User's Guide

RIGOL

Publication number UGA07117-1110

Dec. 2014

DS1000E, DS1000D Series Digital Oscilloscopes

DS1102E, DS1052E, DS1102D, DS1052D

1. © 2008 RIGOL Technologies, Inc. All Rights Reserved
2. RIGOL products are protected by patent law in and outside of P.R. China.
3. Information in this publication replaces all previously corresponding material.
4. RIGOL Technologies, Inc. reserves the right to modify or change part of or all the specifications and pricing policies at company's sole decision.

NOTE: RIGOL is registered trademark of **RIGOL** Technologies, Inc.

Safety Notices

Review the following safety precautions carefully before operating the instrument to avoid any personal injuries or damages to the instrument and any products connected to it. To avoid potential hazards use the instrument as specified by this user's guide only.

The instrument should be serviced by qualified personnel only.

Avoid Fire or Personal Injury.

Use Proper Power Cord. Use the power cord designed for the instrument and authorized in your country only.

Connect and Disconnect Accessories. Do not connect or disconnect probes or test leads while they are connected to a voltage source.

Ground The Instrument. The oscilloscope is grounded through the grounding conductor of the power cord. To avoid electric shock the instrument grounding conductor(s) must be grounded properly. Before making connections to the input or output terminals of the instrument.

Connect The Probe. The probes' ground terminals are at the same voltage level of the instrument ground. Do not connect the ground terminals to a high voltage.

Observe All Terminal Ratings. To avoid fire or shock hazard, observe all ratings and marks on the instrument. Follow the user's guide for further ratings information before making connections to the instrument.

Do Not Operate Without Covers. Do not operate the instrument with covers or panels removed.

Use Proper Fuse. Use the fuse of the type, voltage and current ratings as specified for the instrument.

Avoid Circuit or Wire Exposure. Do not touch exposed connections and components when power is on.

Do Not Operate With Suspected Failures. If suspected damage occurs with the instrument, have it inspected by qualified service personnel before further operations.

Provide Proper Ventilation. Refer to the installation instructions for proper ventilation of the instrument.

Do not operate in wet/damp conditions

Do not operate in an explosive atmosphere

Keep product surfaces clean and dry

The disturbance test of all the models meet the limit values of A in the standard of EN 61326: 1997+A1+A2+A3, but can't meet the limit values of B.

Measurement Category

The DS1000E, DS1000D series Digital Oscilloscope is intended to be used for measurements in Measurement Category I.

Measurement Category Definitions

Measurement Category I is for measurements performed on circuits not directly connected to MAINS. Examples are measurements on circuits not derived from MAINS, and specially protected (internal) MAINS derived circuits. In the latter case, transient stresses are variable; for that reason, the transient withstand capability of the equipment is made known to the user.

WARNING

IEC Measurement Category I, The input terminals may be connected to circuit terminal in IEC Category I installations for voltages up to 300 VAC. To avoid the danger of electric shock, do not connect the inputs to circuit's voltages above 300 VAC. Transient overvoltage is also present on circuits that are isolated from mains. The DS1000E, DS1000D series Digital Oscilloscopes is designed to safely withstand occasional transient overvoltage up to 1000Vpk. Do not use this equipment to measure circuits where transient overvoltage could exceed this level.

Safety Terms and Symbols

Terms in This Guide: These terms may appear in this guide:



WARNING: Warning statements identify conditions or practices that could result in injury or loss of life.



CAUTION: Caution statements identify conditions or practices that could result in damage to this product or other property.

Terms on the Product: These terms may appear on the product:

DANGER: indicates an injury hazard may be immediately accessible.

WARNING: indicates a potential injury hazard may be immediately accessible.

CAUTION: indicates that a potential damage to the instrument or other property might occur.

Symbols on the Product: These symbols may appear on the product:



**Hazardous
Voltage**



**Safety
Warning**



**Protective
Earth Terminal**



**Grounding
Terminal
of Chassis**



**Test
Grounding
Terminal**

General-Purpose Oscilloscopes

This book covers the following four types of DS1000E, DS1000D Series Digital Oscilloscopes:

DS1102E, DS1052E

DS1102D, DS1052D (With Logic Analyzer)

DS1000E, DS1000D series are kinds of economical digital oscilloscope with high-performance. DS1000E series are designed with dual channels and 1 external trigger channel. DS1000D series are designed with dual channels and 1 external trigger channel as well as 16 channels logic analyzer.

The front panel of DS1000E, DS1000D series digital oscilloscopes are clear, direct viewing and easy to use, which consistent with the traditional instrument use fully. To speed up the adjustment and measurement, please press **AUTO** button to get suitable waveform display and settings. Besides, 1GSa/s maximum real-time sample rate, 25GSa/s maximum equivalent sample rate and the powerful trigger and analyzer functions enable users view or capture the waveform more detailed and faster.

Main Features

- Dual analog channels, 1GSa/s maximum real-time sample rate and 25GSa/s maximum equivalent sample rate, Bandwidth of per channel:
100MHz (DS1102E, DS1102D)
50MHz (DS1052E, DS1052D)
- Optional 16 digital channels (DS1000D series), each channel can be turned on or off independently, or in a 8 bit group
- 5.6 inch and 64 k TFT LCD
- Abundant trigger types: Edge, Pulse Width, Video, Slope, Alternate, Pattern and Duration Trigger (Only for DS1000D series)
- Unique adjustable trigger sensitivity enables to meet different demands
- Enable to measure 22 types of wave parameters and track measurements via cursor automatically
- Unique waveform record and replay function
- Fine delayed scan function
- Built-in FFT function, hold practical digital filters

RIGOL

- Provide 4 types of digital filters: LPF, HPF, BPF, BRF
- Pass/Fail detection function enables to output testing results
- Math operations available to multiple waves
- Powerful PC application software UltraScope
- Standard configuration interface: USB Device, USB Host ,RS-232 and support USB storage device storage and PictBridge print standards
- The new function "Special Mode" can meet the needs of industrial production
- Support for remote command control
- Built-in help menu enables information getting more convenient
- Multiple Language User Interface, support Chinese & English input
- Can store files into USB storage device or the internal memory
- Waveform intensity can be adjusted
- To display a signal automatically by **AUTO**
- Pop-up menu makes it easy to read and use

Content

Safety Notices.....	II
General-Purpose Oscilloscopes.....	V
Chapter 1 Quick Start	1-1
To Inspect the Instrument	1-2
The Panels and User Interface.....	1-3
Appearance and Dimensions.....	1-7
To Perform a Functional Check	1-8
To Compensate Probes	1-10
Digital Leads (Only for DS1000D Series)	1-11
To Display a Signal Automatically.....	1-13
To Understand the Vertical System	1-14
To Understand the Horizontal System.....	1-16
To Understand the Trigger System.....	1-18
Chapter 2 Operating Your Oscilloscope	2-1
To Set up the Vertical System.....	2-2
To Set up the Horizontal System.....	2-27
To Set up the Trigger System	2-34
To Set up the Sampling System	2-53
To Set up the Display System	2-57
To Store and Recall	2-59
To Set up the Utility System	2-67
To Measure Automatically	2-88
To Measure with Cursors.....	2-95
To Use Run Control Buttons	2-102
Chapter 3 Application & Examples.....	3-1
Example 1: Taking Simple Measurements	3-1
Example 2: View a Signal Delay Caused by a Circuit.....	3-2
Example 3: Capture a Single-Shot Signal	3-3
Example 4: To Reduce the Random Noise on a Signal.....	3-4
Example 5: Making Cursor Measurements	3-6
Example 6: The application of the X-Y operation	3-8
Example 7: Triggering on a Video Signal.....	3-10
Example 8: FFT Cursor measurement	3-12

Example 9: Pass/Fail Test 3-13

Example 10: Triggering on a Digital Signal 3-14

Chapter 4 Troubleshooting 4-1

Chapter 5 Specifications 5-1

 Specifications 5-2

 General Specifications 5-6

Chapter 6 Appendix 6-1

 Appendix A: Accessories 6-1

 Appendix B: Warranty 6-2

 Appendix C: Care and Cleaning 6-3

 Appendix D: Contact Us..... 6-4

Index 1

Chapter 1 Quick Start

This chapter covers the following topics:

- To Inspect the Instrument
- The Panels and User Interface
- Appearance and Dimensions
- To Perform a Functional Check
- To Compensate Probes
- Digital Leads (Only for DS1000D Series)
- To Display a Signal Automatically
- To Understand the Vertical System
- To Understand the Horizontal System
- To Understand the Trigger System

To Inspect the Instrument

When you get a new DS1000E, DS1000D series oscilloscope, please inspect the instrument according to the following steps:

1. Inspect the shipping container for damage.

Keep a damaged shipping container or cushioning material until the contents of the shipment have been checked for completeness and the instrument has been checked mechanically and electrically.

2. Inspect the instrument.

In case there is any mechanical damage or defect, or the instrument does not operate properly or fails performance tests, please notify the **RIGOL** Sales Representative.

If the shipping container is damaged, or the cushioning materials show signs of stress, please notify the carrier as well as the **RIGOL** sales office. Keep the shipping materials for the carrier's inspection. **RIGOL** offices will arrange for repair or replacement at **RIGOL**'s option without waiting for claim settlement.

3. Check the accessories.

Accessories supplied with the instrument are listed in "Appendix A: Accessories" in this guide.

If the contents are incomplete or damaged, please notify your **RIGOL** Sales Representative.

The Panels and User Interface

The first thing to do with a new oscilloscope is to know its front panel. This chapter helps to be familiar with the layout of the knobs and buttons and how to use them. Read the chapter carefully before further operations.

1. Front Panel

Figure 1- 1, Front Panel; the knobs are used most often and are similar to the knobs on other oscilloscopes. The buttons allow you to use some of the functions directly but also bring up soft button menus on the screen, which enable the access to many measurement features associated with advanced functions, mathematics, and reference or to run control features.

- The front panel of DS1000E:

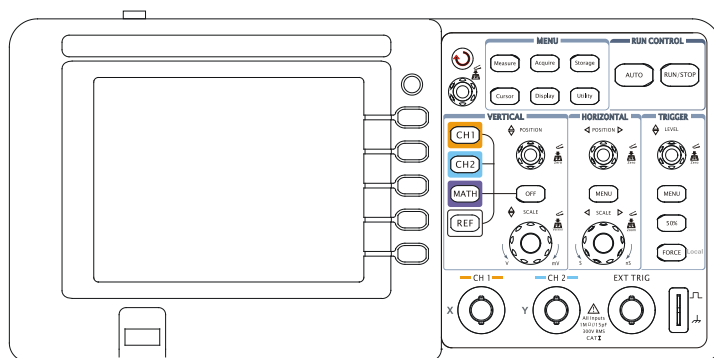

- The front panel of DS1000D:

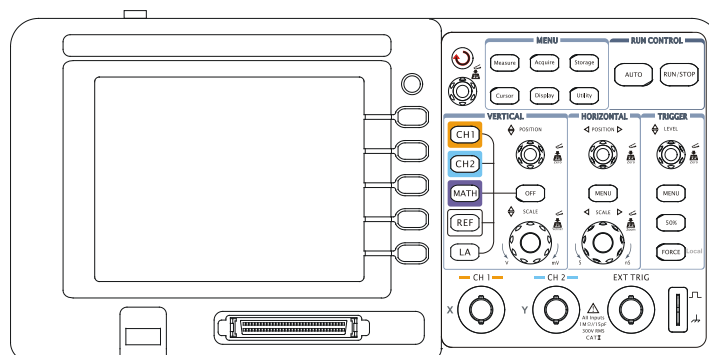

Figure 1- 1

Front Panel Figure of DS1000E, DS1000D Series Oscilloscope

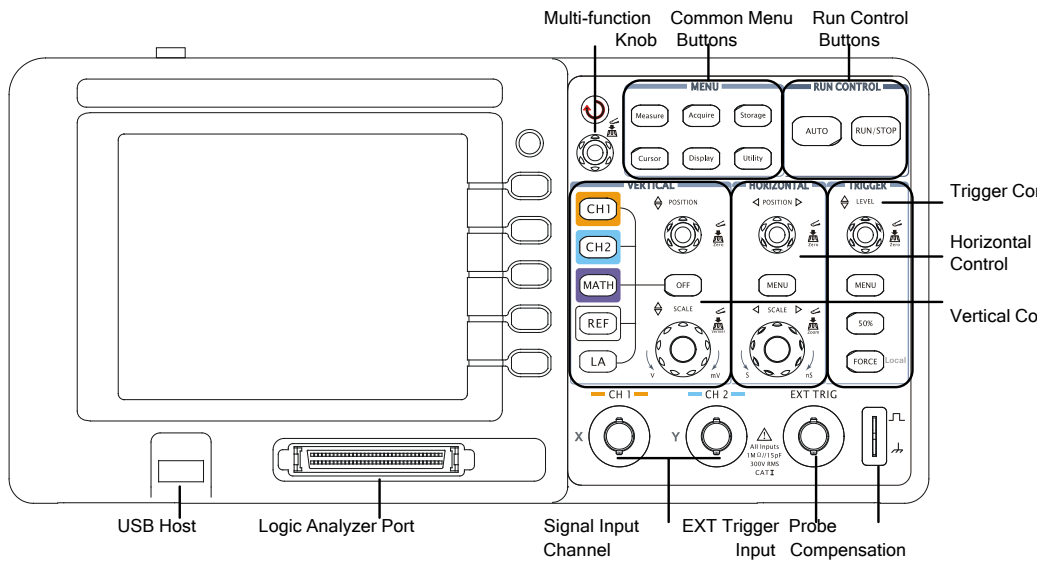

Figure 1- 2
Front Panel Instruction

2. Rear Panel



Figure 1- 3
Rear Panel Figure of DS1000E, DS1000D Series Oscilloscope

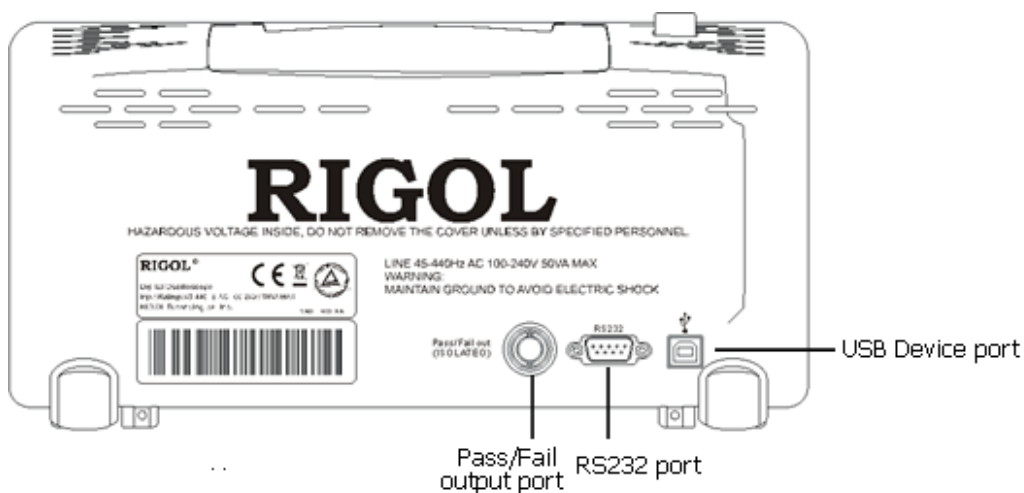







Figure 1- 4
Rear Panel Instruction

Rear Panel of DS1000E, DS1000D series contains the following parts:

- ① **Pass/Fail output port:** The Pass/Fail testing results can be output by the port.
- ② **RS232 port:** To connect the oscilloscopes and external equipment as serial port.
- ③ **USB Device port:** It is used to transfer data when external USB equipment connects to the oscilloscope regarded as "Device equipment". For example: to use this port when connect PictBridge printer to the instrument by USB.

Notation definitions in this User's Guide:

Throughout this manual, notation symbols of buttons and knobs are the same to those on front-panel.

- A box around the name of the button denotes MENU function buttons on front-panel, such as Measure.
-  denotes the multi-function knob .
-  POSITION denotes the two POSITION knobs.
-  SCALE denotes the two SCALE knobs.
-  LEVEL denotes the LEVEL knob.
- The name with a drop shadow denotes the menu operating button, such as Storage denoting the "Storage" menu item under Measure.

3. User Interface

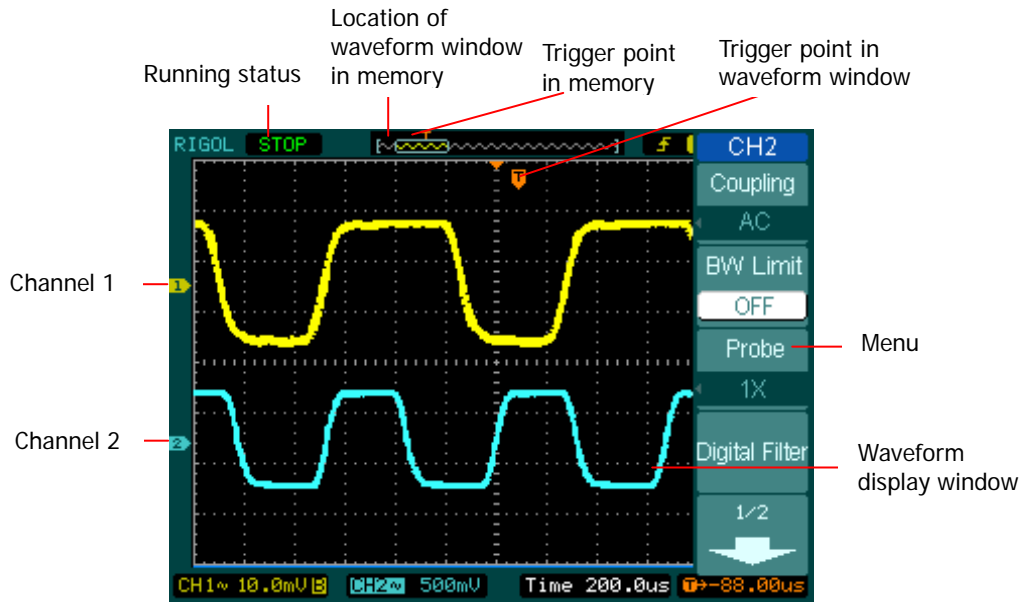

Figure 1- 5
Display screen (Analog channels only)

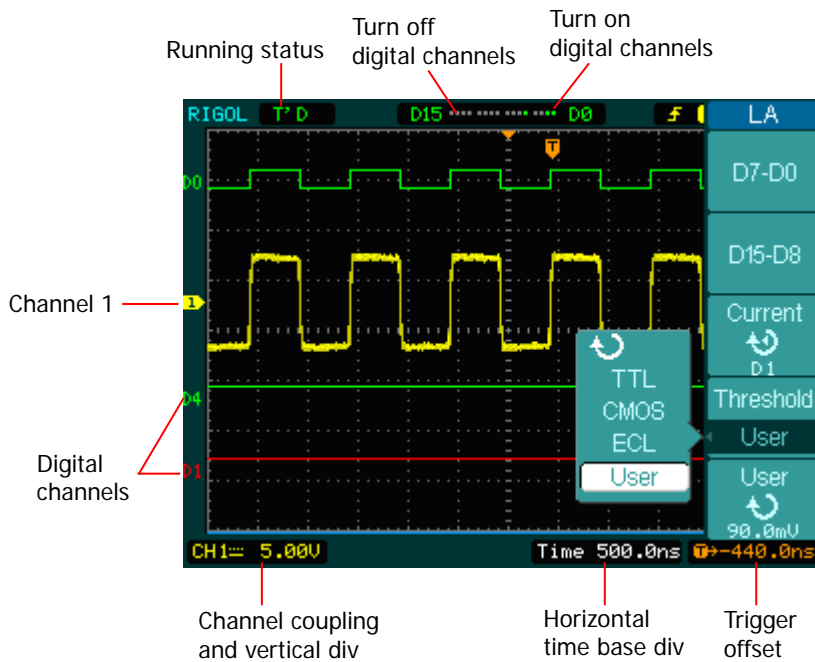

Figure 1- 6
User Interface (Analog and Digital channels)

Appearance and Dimensions

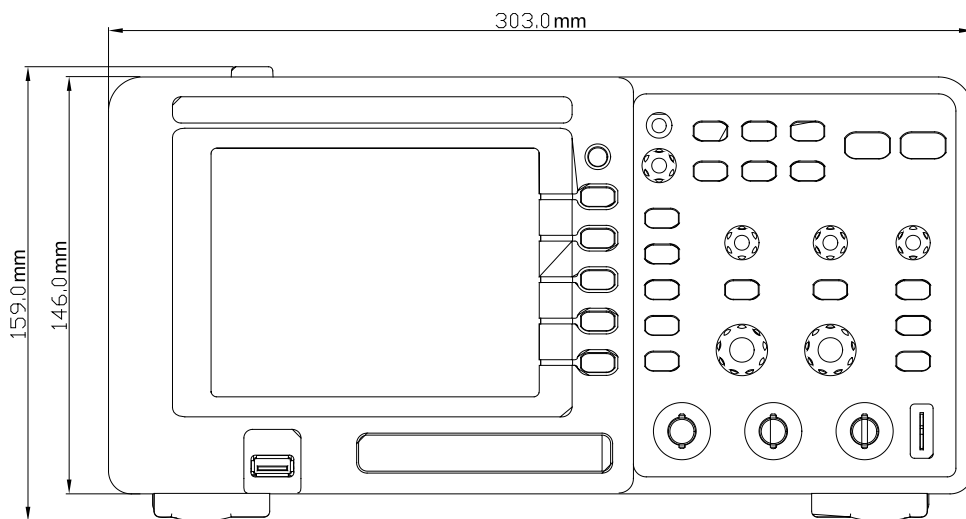

Figure 1- 7 Front View

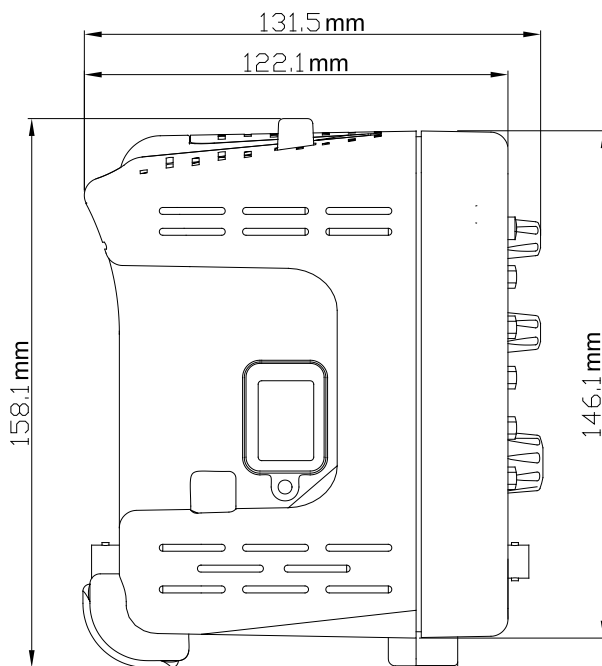

Figure 1- 8 Side View

To Perform a Functional Check

Perform this quick functional check to verify that the instrument is operating correctly.

1. Turn on the instrument.

- Use the power cord designed for the oscilloscope only.
- The power requirements are 100 to 240 VAC_{RMS}, 45Hz to 440Hz.
- Turn on the instruments, and wait until the display shows the waveform window.
- Press the **Storage** button, select **Storage** in the menu. Rotate the multiple function knob to select **Factory** and press the knob down. Then, press **Load**.

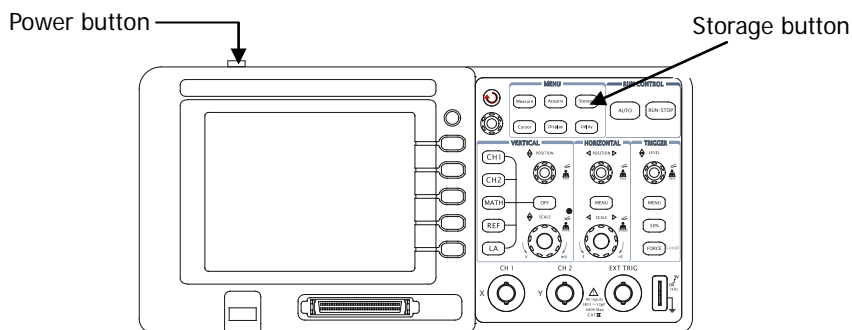

Figure 1- 9

Turn on and Check the instrument



WARNING:

To avoid electric shock, be sure the oscilloscope is properly grounded.

2. Input a signal to a channel of the oscilloscope

DS1000E series: 2 channels input + 1 external trigger channel input

DS1000D series: 2 channels input + 1 external trigger channel input +16 channels digital input

Do the following steps:

- ① Set the switch on the probe to 10X and connect the probe to Channel1 on the oscilloscope:

- Align the slot in the probe connector with the button on the CH1 BNC.
- Push to connect, and twist to the right to lock the probe.
- Attach the probe tip and ground lead to the PROBE COMP connector.

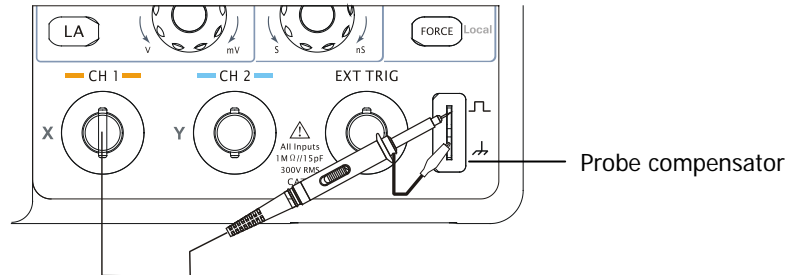

Figure 1- 10
Attach the probe

- ② Set the probe attenuation to 10X. To do this, push **CH1** → **Probe** → **10X**.

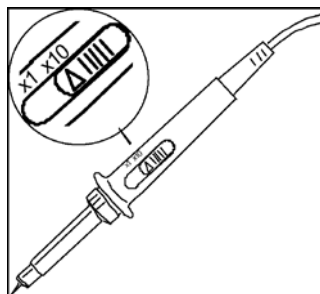

Figure 1- 11
Set attenuation on the probe

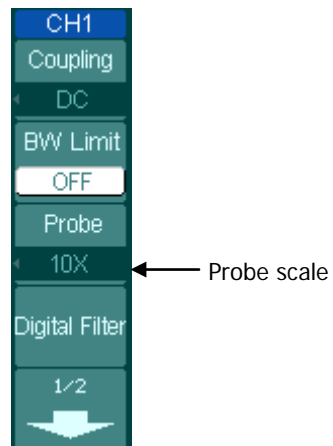

Figure 1- 12
Set attenuation in the menu

- ③ Push the **AUTO** button. Within a few seconds, a square wave will display.
- ④ Push the **CH1** button again to turn off Channel1.
Push the **CH2** button to turn on channel2, repeat steps 2 and 3.

NOTE: The signal output from Probe compensator should only be used for probe compensation, not for calibration.

To Compensate Probes

Perform this adjustment to match the characteristics of the probe and the channel input. This should be performed whenever attaching a probe to any input channel for the first time.

1. From CH1 menu, set the Probe attenuation to 10X (press **CH1** → **Probe** → **10X**). Set the switch to 10X on the probe and connect it to CH1 of the oscilloscope. When using the probe hook-tip, inserting the tip onto the probe firmly to ensure a proper connection. Attach the probe tip to the Probe compensator connector and the reference lead to the ground pin, Select CH1, and then press **AUTO**.
2. Check the shape of the displayed waveform.

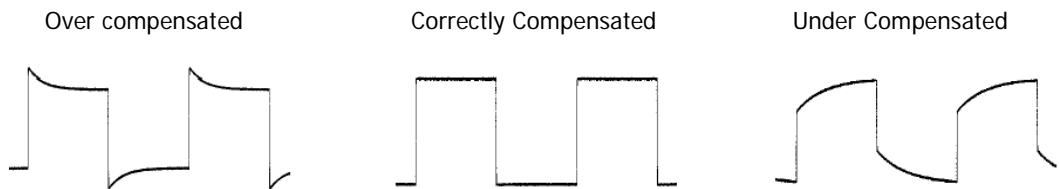

Figure 1- 13
Probe Compensation

3. If necessary, use a non-metallic tool to adjust the trimmer capacitor on the probe for the flattest square wave possible as displayed on the oscilloscope.
4. Repeat as necessary.



WARNING: To avoid electric shock while using the probe, be sure the perfection of the insulated cable, and do not touch the metallic portions of the probe head while it is connected with a voltage source.

Digital Leads (Only for DS1000D Series)

Digital leads are provided only for DS1000D series which have Logic Analyzer.

1. Switch off power supply of the device under test if necessary to avoid short circuit. Since no voltage is applied to the leads at this step, you may keep the oscilloscope on.
2. Connect one end of the flat cable FC1868 to the Logic Analyzer Input; connect the other end to Logic Head LH1116. An identifier is located on each end of the flat cable; it can only be connected in one way. It is unnecessary to switch off power supply of your oscilloscope when connecting the cable.

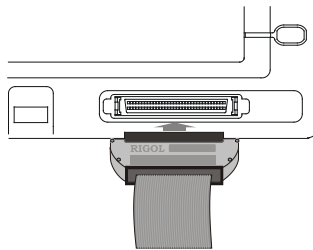

Figure 1- 14
Connect the digital leads



CAUTION: Use only FC1868, LH1116, TC1100 and LC1150 made by **RIGOL** for specified DS1000D series.

3. Connect a test clip to one lead wire; make sure it's connection good.

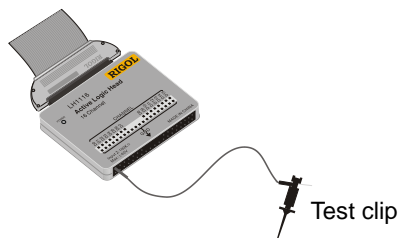

Figure 1- 15
Input Interface of Digital Channel

4. Test your device with the clip.

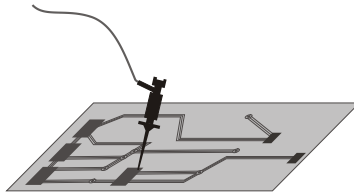

Figure 1- 16
Digital Channel Measurement

5. Remember to connect Ground Channel to the DUT's ground terminal.

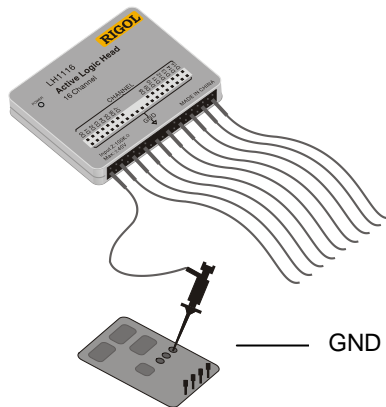

Figure 1- 17
Connecting to the Ground

To Display a Signal Automatically

The oscilloscope has an automated feature to display the input signal best-fit. The input signal should be 50Hz or higher and a duty cycle is greater than 1%.

Use Auto Setting:

1. Connect a signal to the oscilloscope as described above.
2. Press **AUTO**.

The oscilloscope will automatically set up VERTICAL, HORIZONTAL and TRIGGER controls to display the input signal. Adjust the controls manually to get the best results if necessary.

To Understand the Vertical System

Figure 1- 18 shows the VERTICAL controls, **CH1**, **CH2**, **MATH**, **REF** and **OFF** buttons and vertical **POSITION**, **SCALE** knobs. Following the exercise of the buttons, knobs, and the status bar to be familiar with the vertical parameters settings.

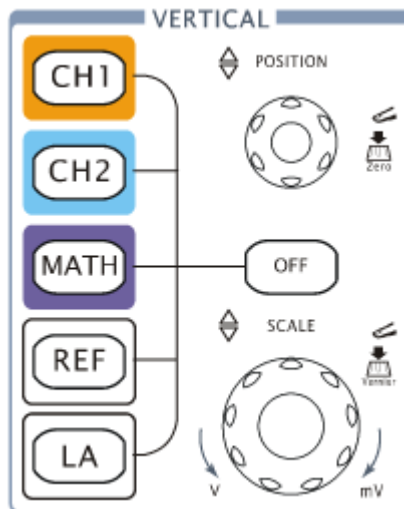

Figure 1- 18
The vertical system

1. Moves the signal vertically on the display with the **POSITION** knob.



When turning the **POSITION** knob, a voltage value is displayed for a short time indicating its value with respect to the ground reference located at the center of the screen. Also notice that the ground symbol on the left side of the display moves in conjunction with the **POSITION** knob.

Measurement hints







If the channel is DC coupled, measuring the DC component of the signal by simply noting its distance from the ground.

If the channel is AC coupled, the DC component of the signal is blocked, allow you to use greater sensitivity to display the AC component of the signal.

Vertical offset back to 0 shortcut key

Turn the  POSITION knob to change the vertical display position of channel and press the  POSITION knob to set the vertical display position back to 0 as a shortcut key, this is especially helpful when the trace position is far out of the screen and want it to get back to the screen center immediately.

2. Change the vertical setup and notice that each change affects the status bar differently.

- View the status bar which is on the bottom of the screen to understand the vertical scale.
- Change the vertical scale by turning the  SCALE knob and notice the change in the status bar.
- Press , , , ,  (only for DS1000D series) to display the menu, sign, waveform of corresponding channel. Press  button to turn off the channel.

Coarse/Fine Shortcut key

The Coarse/Fine vertical control can be set by simply pressing the vertical  SCALE knob.

To Understand the Horizontal System

Figure 1-19 shows the HORIZONTAL controls: **MENU** button, **POSITION** and **SCALE** knobs of horizontal system. Following the exercise to familiarize with the buttons, knobs, and status bar.

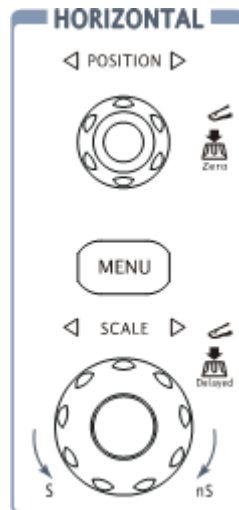

Figure 1- 19
The horizontal system

1. Turn the **SCALE** knob and notice the change in the status bar.

The horizontal **SCALE** knob changes the sweep speed in a 1-2-5 step sequence, and displays the value in the status bar. The time base ranges of the oscilloscope is from 2ns/div* to 50s/div.

Delayed Scan Shortcut key

To press the **SCALE** knob in the horizontal control area on the front-panel is another way to enter or exit Delayed Scan mode and it is equal to the following menu operations, **MENU** → **Delayed** → **ON**.

* **NOTE:** The speed of horizontal scan varies by different models.

2. **The horizontal  POSITION knob moves displayed signal horizontally on waveform window**

Turn the horizontal  POSITION knob to adjust trigger offset. The waveform will move horizontally at the same time.

Horizontal offset back to 0 shortcut key

Press the  POSITION knob to set the horizontal offset to 0 as a shortcut key, this is especially helpful when the trigger point is far out of the screen and want it to get back to the screen center immediately.

3. **Press the  MENU button to display the TIME menu.**

To enter or exit the Delayed Scan mode, set the display to Y-T, X-Y or ROLL mode, or reset the trigger offset.

Horizontal position control

Trig-Offset: The position of the practical trigger point relative to center of the memory. Adjust the horizontal  POSITION knob to move the trigger point horizontally.

To Understand the Trigger System

Figure 1-20 shows the trigger control: MENU, 50%, FORCE and a  LEVEL trigger level knob. Following the exercise to familiarize with the buttons, trigger level knob and status bar.

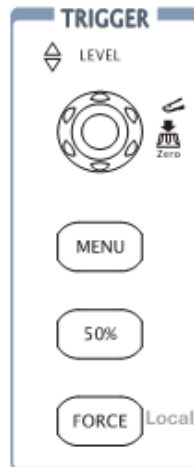



Figure 1-20



The trigger control window

1. Turn the trigger Level knob and notice the changes on the display.

As you turn the  LEVEL knob or pressing the 50% button, two things will happen on the display for a short time.

- First, the trigger level value is displayed at the bottom-left of the screen.
- Second, a line is displayed showing the location of the trigger level (as long as AC coupling or low frequency reject are not selected).

Trigger Level to 0 Shortcut key

Turn the  LEVEL knob to change trigger level value and press the  LEVEL knob to set trigger level back to 0 as a shortcut key.

2. Change the trigger setup and notice these changes in the status bar.

Press **MENU** button in the Trigger control. A soft button menu appears on the display showing the trigger setting choices as shown in Figure 1-21.

Figure 1- 21



- Press the trigger **Mode** button and choose **Edge**.
- Press the trigger **Source** button to select **CH1**.
- Press the trigger **Slope** button to choose **↕**.
- Press the trigger **Sweep** button to select **Auto**.
- Press the trigger **Set Up** button to enter secondary menu.

NOTE: The trigger type, slope and source change in conjunction with the status bar on the top-right of the screen.

3. Press **50%**

The **50%** button sets the trigger level to the center of the signal.

4. Press **FORCE**

Starting an acquisition regardless of an adequate trigger signal, usually used in "Normal" or "Single" trigger mode. This button has no effect if the acquisition is already stopped.

Key point:

Holdoff: A time interval before the oscilloscope response to next trigger signal. During this holdoff period, the trigger system becomes "blind" to trigger signals. This function helps to view complex signals such as an AM waveform. Press **Holdoff** button to activate (↻) knob, then turn it to adjust Holdoff time.

Chapter 2 Operating Your Oscilloscope

By now, a user should understand the VERTICAL, HORIZONTAL and TRIGGER control systems and knows how to determine the system setup by status bar of a DS1000E, DS1000D series digital oscilloscope.

This chapter will go through all groups of front-panel buttons, knobs and menus; and further the knowledge of the operation by hints in this guide.

It is recommended to perform all of the following exercises to get the most of the powerful measurement capabilities of the oscilloscope.

This chapter contains the following topics:

- To Set up the Vertical System
(**CH1**, **CH2**, **MATH**, **REF**, **LA** (for DS1000D series) **OFF**, Vertical **POSITION**, Vertical **SCALE**)
- To Set up the Horizontal System
(**MENU**, Horizontal **POSITION**, Horizontal **SCALE**)
- To Set up the Trigger System (**LEVEL**, **MENU**, **50%**, **FORCE**)
- To Set up the Sampling System (**Acquire**)
- To Set up the Display System (**Display**)
- To Store and Recall (**Storage**)
- To Set up the Utility System (**Utility**)
- To Measure Automatically (**Measure**)
- To Measure with Cursors (**Cursor**)
- To Use Run Control Buttons (**AUTO**, **RUN/STOP**)

Please refer to this chapter more carefully to get more information of the measurement and operation methods of DS1000E and DS1000D.

To Set up the Vertical System

Settings of the Channels

This series oscilloscopes offer dual channels. Each channel has an operation menu and it will pop up after pressing **CH1** or **CH2** button. The settings of all items in the menu is shown in the table below.

Figure 2- 1 Table 2- 1 The Channel menu (Page 1/2)



Menu	Settings	Comments
Coupling	AC	Blocks the DC component of the input Signal
	DC	Passes both AC and DC components of the input signal
	GND	Disconnects the input signal
BW Limit	ON	Limits the channel bandwidth to 20MHz to reduce display noise.
	OFF	Get full bandwidth.
Probe	1X	Set this to match your probe attenuation factor to make the vertical scale readout correct
	5X	
	10X	
	50X	
	100X	
	500X	
1000X		
Digital filter		Setup digital filter (See table 2-4)
	1/2	Go to the next menu page (The followings are the same, no more explanation)

Figure 2- 2 Table 2- 2 The Channel Menu (Page 2/2)



Menu	Settings	Comments
	2/2	Back to the previous menu page (The followings are the same, no more explanation)
Volts/Div	Coarse Fine	Selects the resolution of the SCALE knob Defines a 1-2-5 sequence. To change the resolution to small steps between the coarse settings.
Invert	ON OFF	Turn on the invert function. Restore original display of the waveform.

1. Channel coupling

To use Channel 1 as an example, input a sine wave signal with DC shift.

Press **CH1**→**Coupling**→**AC** to set “AC” coupling. It will pass AC component and blocks the DC component of the input signal. The waveform is displayed as Figure 2-3:

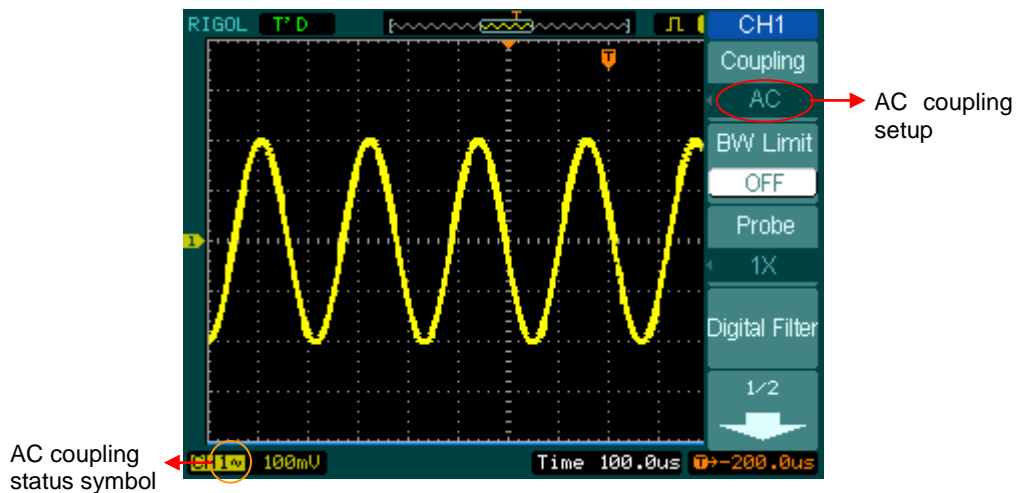

Figure 2- 3
AC coupling setting

Press **[CH1]** → **Coupling** → **DC**, to set "DC" coupling. It will pass both AC and DC components of the input signal. The waveform is displayed as Figure 2- 4:

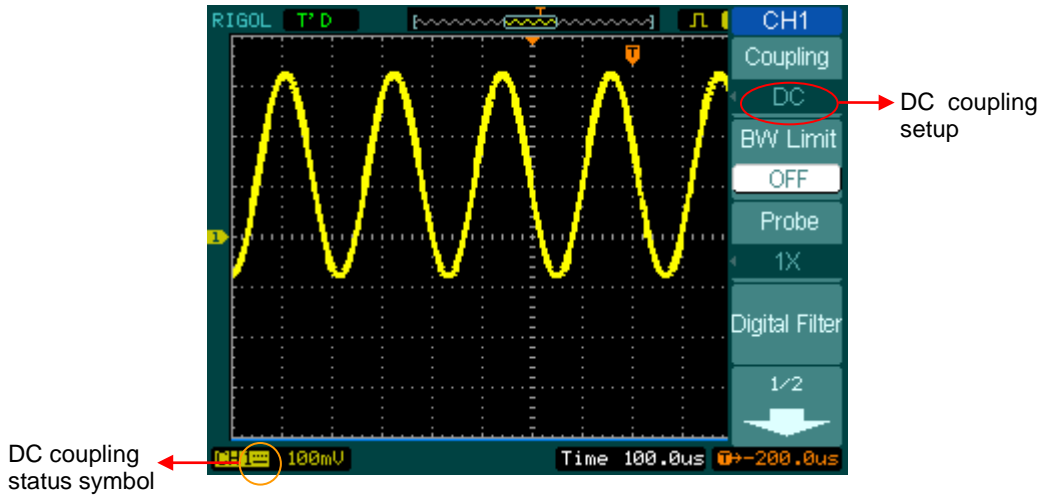

Figure 2- 4
DC coupling setting

Press **[CH1]** → **Coupling** → **GND**, to set "GND" coupling, it blocks the input signal. The screen displays as Figure 2-5:

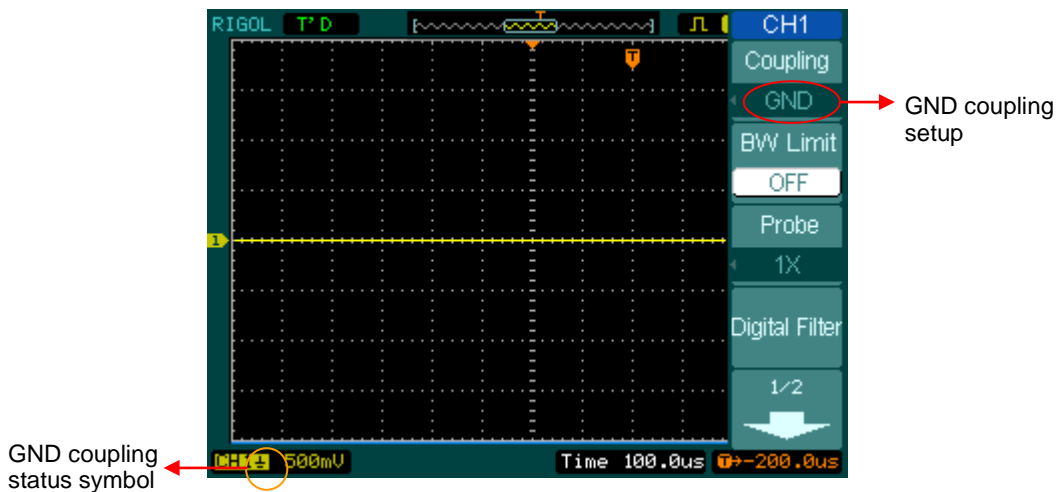

Figure 2- 5
GND coupling setting

2. Set up the channel bandwidth limit

To take Channel1 as an example, input a signal containing high frequency component. Press **CH1** → **BW Limit** → **OFF**, to set up bandwidth limit to “OFF” status. The oscilloscope is set to full bandwidth and passing the high frequency component in the signal. The waveform is displayed as Figure 2- 6:

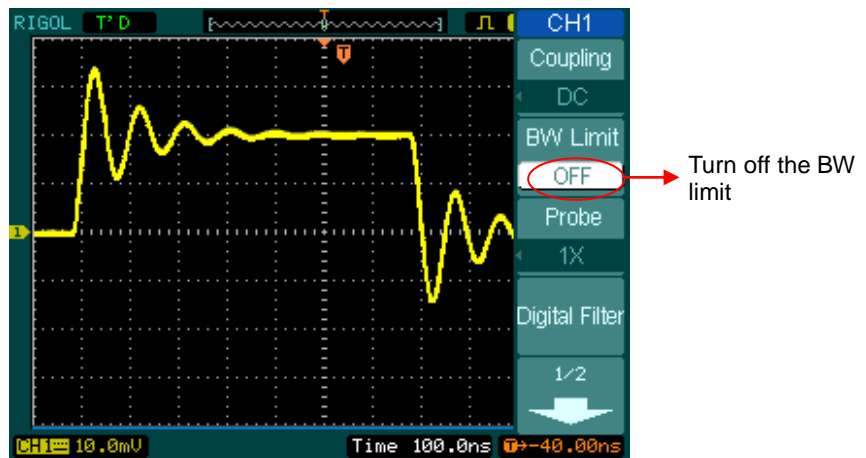

Figure 2- 6

Turn off the BW limit

Press **CH1** → **BW Limit** → **ON**, to set up bandwidth limit to “ON” status. It will reject the frequency component higher than 20MHz.

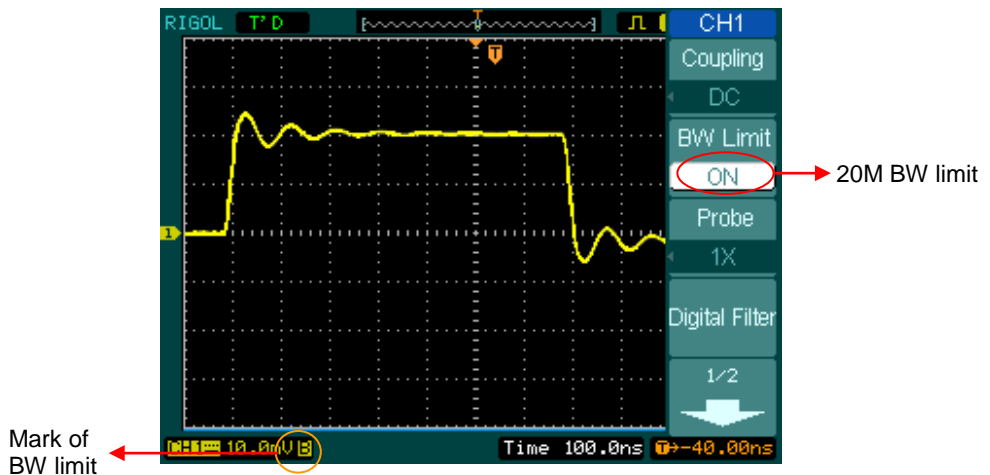

Figure 2- 7

Turn on the BW limit

3. Probe Attenuation Setting

The oscilloscope allows selecting the attenuation factor for the probe. The attenuation factor changes the vertical scaling of the oscilloscope so that the measurement results reflect the actual voltage levels at the probe tip.

To change (or check) the probe attenuation setting, press the **CH1** or **CH2** button (according to which channel in using). Press the **Probe** soft button to match the attenuation factor of the probe. This setting remains in effect until changed again.

Figure 2-8 shows an example for using a 1000:1 probe and its attenuation factor.

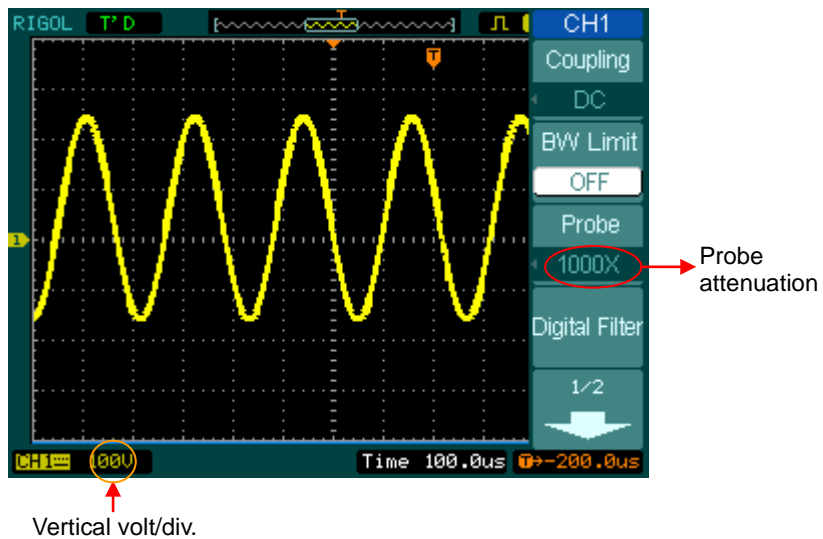

Figure 2- 8

Use the 1000:1 attenuation

Table 2- 3 Probe setting

Probe attenuation factors	Corresponding settings
1:1	1X
5:1	5X
10:1	10X
50:1	50X
100:1	100X
500:1	500X
1000:1	1000X

4. Digital Filter settings

DS1000E, DS1000D series offer 4 types of digital filters (Low Pass Filter, High Pass Filter, Band Pass Filter and Band Reject Filter). In order to achieve a good filter effect, you can filter the special waveform frequency by setting up the range of filter bandwidth. Press **CH1**→Digital filter, display the digital filter menu. Turn (↻) knob to set high and low limit of frequency.

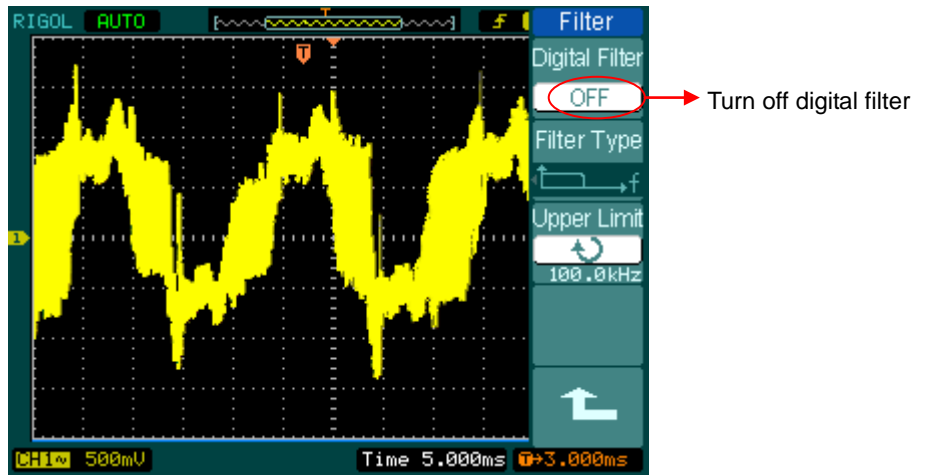
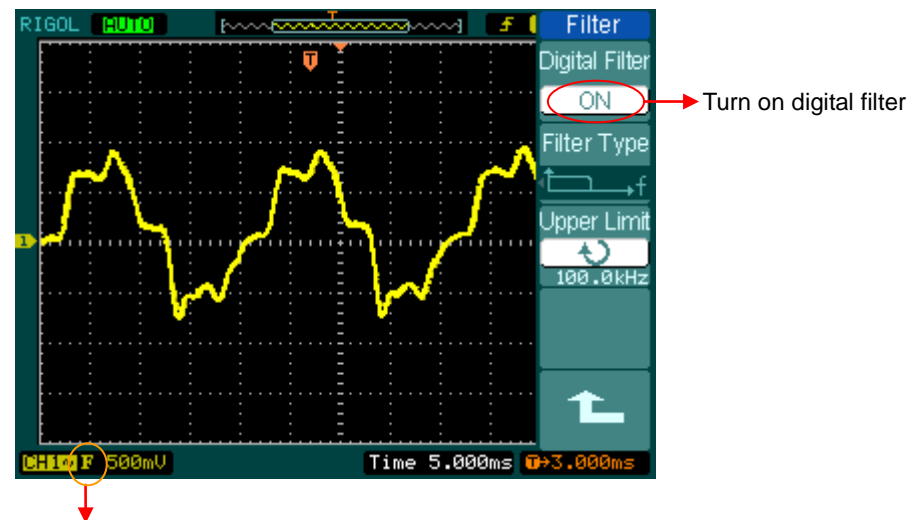

Figure 2- 9

The waveform when turning off digital filter









Mark of digital filter

Figure 2- 10

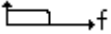
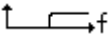
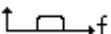
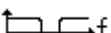
The waveform when turning on digital filter

Figure 2- 11 Table 2- 4 The Filter menu



Menu	Settings	Comments
Digital Filter	ON OFF	Turn on the digital filter Turn off the digital filter
Filter Type	 f  f  f  f	Setup as LPF (Low Pass Filter) Setup as HPF (High Pass Filter) Setup as BPF (Band Pass Filter) Setup as BRF (Band Reject Filter)
Upper limit	 <frequency>	Turn () knob to set high limit
Lower limit	 <frequency>	Turn () knob to set low limit
		Back to higher level menu (The followings are the same)

5. Volts/Div settings

The **Volts/Div** control has **Coarse** or **Fine** configuration. The Vertical Sensitivity is 2mV/div - 10V/div. **Coarse**: It is the default setting of Volts/Div in a 1-2-5-step sequence from 2mV/div, 5mV/div, 10mV/div, 20mV/div.....10V/div. **Fine**: This setting changes the vertical scale to small steps between the coarse settings. It will be helpful to adjust the waveform in smooth steps.

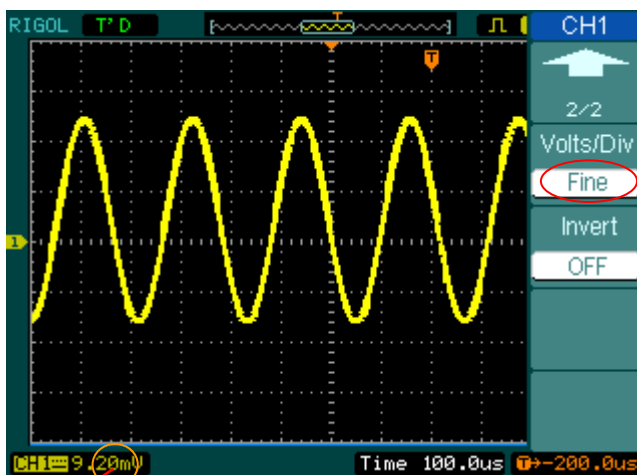

Fine adjustment data Figure 2- 12 Fine configurations

Coarse/Fine Shortcut key:

To change Coarse/Fine setting, not only by menu but also by pressing vertical  SCALE knob

6. To invert a waveform

Invert turns the displayed waveform 180 degrees, as respect to the ground level. Figure 2- 13 and Figure 2- 14 show the changes after inversion.

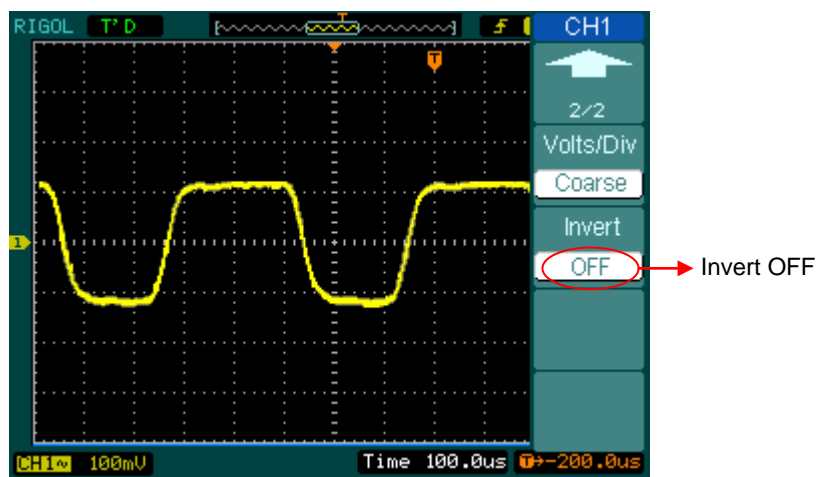

Figure 2- 13 The waveform before inversion

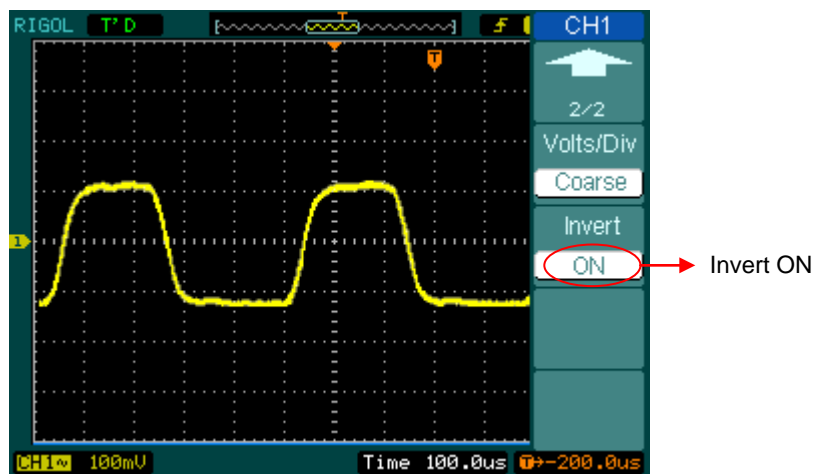

Figure 2- 14 The waveform after inversion

Math Functions

The mathematic functions include “Add”, “Subtract”, “Multiply” and “FFT” for Channel 1 and Channel 2. The mathematic result can be measured by grid and cursor. Press **MATH** button, the system enter the MATH interface as follows:

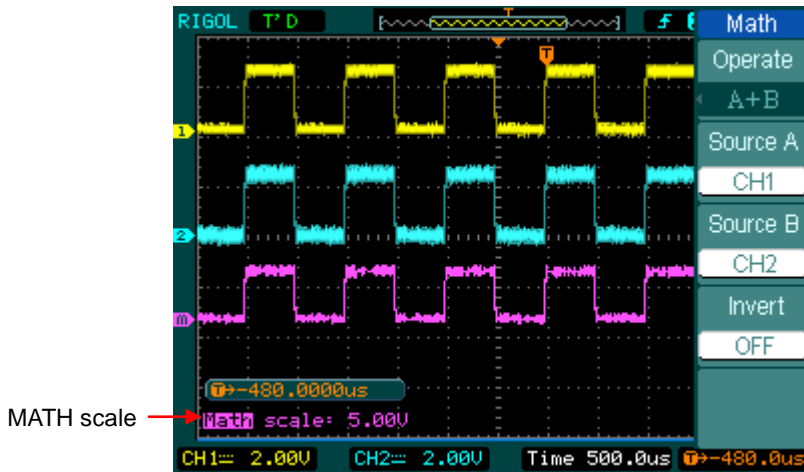

Figure 2- 15
The Math function

Figure 2- 16 Table 2- 5 The Math menu



Menu	Settings	Comments
Operation	A+B	Add source A and source B
	A-B	Subtract source B from source A
	A×B	Multiply source B by source A
	FFT	Fast Fourier Transform
Source A	CH1	Define CH1 or CH2 as source A
	CH2	
Source B	CH1	Define CH1 or CH2 as source B
	CH2	
Invert	ON	Invert the MATH waveform. Restore to original waveform display.
	OFF	

1. Using the FFT

FFT (Fast Fourier Transform) transforms time domain signals to frequency domain signals. The horizontal axis shows the frequency and the vertical axis shows the amplitude dBVrms or Vrms. FFT function can not only to help you find crossfire problem and analog waveform distortion caused by nonlinear amplifier, but also can adjust the analog filter.

FFT waveforms are useful in the following applications:

- Measuring harmonic content and distortion in systems
- Characterizing noise in DC power supplies
- Analyzing vibration

Press **MATH** → **Operate** → **FFT**, to display FFT menu.

Figure 2- 17



Table 2- 6 The FFT menu

Menu	Settings	Comments
Operate	A+B A-B A x B FFT	Add source A to source B Subtract source B from source A Multiply source B by source A Fast Fourier Transform
Source	CH1 CH2	Define CH1 or CH2 as FFT source
Window	Rectangle Hanning Hamming Blackman	Select window for FFT
Display	Split Full screen	Display FFT waveform on half screen Display FFT waveform on full screen
Scale	Vrms dBVrms	Set "Vrms " as vertical unit Set "dBVrms " as vertical unit

Key points for FFT

Signals that have a DC component or offset can cause incorrect FFT waveform component magnitude values. To minimize the DC component, choose AC Coupling on the source signal.

To reduce random noise and aliases components in repetitive or single-shot events, set the oscilloscope acquisition mode to average.

To display FFT waveforms with a large dynamic range, use the dBVrms scale. The dBVrms scale displays component magnitudes using a log scale.

2. Selecting an FFT Window

The oscilloscopes provide four FFT windows. Each window is a trade-off between frequency resolution and amplitude accuracy. What you want to measure and your source signals characteristics help determine which window to use. Use the following guidelines to select the best window.

Table 2- 7 FFT Windows

Window	Features	Best for measuring
Rectangle	Best frequency Resolution and worst magnitude resolution. This is essentially the same as no window.	Transients or bursts, the signal levels before and after the event are nearly equal. Equal-amplitude sine waves with fixed frequencies. Broadband random noise with a relatively slow varying spectrum.
Hanning Hamming	Better frequency, poorer magnitude accuracy than Rectangular. Hamming has slightly better frequency resolution than Hanning.	Sine, periodic, and narrow-band random noise. Transients or bursts where the signal levels before and after the events are significantly different.
Blackman	Best magnitude, worst frequency resolution.	Single frequency waveforms, to Find higher order harmonics.

Key points:

FFT Resolution: the quotient between sampling rate and number of FFT points. With a fixed FFT points, the lower sampling rate can insure better resolution.

Nyquist Frequency

The highest frequency that any real-time digitizing oscilloscope can acquire without aliasing. It's normally half of the sample rate. This frequency is called the Nyquist frequency. Frequency above the Nyquist frequency will be under sampled, causing a situation known as aliasing.

REF Function

Reference Waveforms are saved waveforms to be selected for display. The reference function will be available after saving the selected waveform to non-volatile memory.

Press **REF** button to display reference waveform menu.

Figure 2- 18 Table 2- 8 REF Menu when using internal memory

REF	Source	CH1	Location	Internal	Save	Imp./Exp.	Reset
Menu	Settings	Comments					
Source	CH1	Select channel1 as REF channel					
	CH2	Select channel2 as REF channel					
	MATH/FFT	Select MATH/FFT as REF channel					
	LA	Select LA as REF channel (DS1000D series)					
Location	Internal	Select memory location in scope					
	External	Select memory location out scope					
Save	/	Save REF waveform					
Imp./Exp.	/	Go to import/export menu(see table 2-10)					
Reset	/	Reset REF waveform					

Figure 2- 19 Table 2- 9 REF Menu when using external memory

REF	Source	CH1	Location	External	Save	Import	Reset
Menu	Settings	Comments					
Source	CH1	Select channel1 as REF channel					
	CH2	Select channel2 as REF channel					
	MATH/FFT	Select Math/FFT as REF channel					
	LA	Select LA as REF channel (DS1000D series)					
Location	Internal	Select internal memory location					
	External	Select external memory location					
Save	/	Save REF waveform to outer memory location					
Import	/	Go to import menu(see table 2-14)					
Reset	/	Reset REF waveform					

1. Import and Export

Press **REF** → **Imp./Exp.** To enter the following menu.

Figure 2- 20 Table 2- 10 The Imp. /Exp. menu

Menu	Settings	Comments
Explorer	Path Directory File	Switch to Path, directory or file
Export		Export the REF file from internal memory to export memory (see table 2-11)
Import		Import the REF file to internal memory
Delete File		Delete file

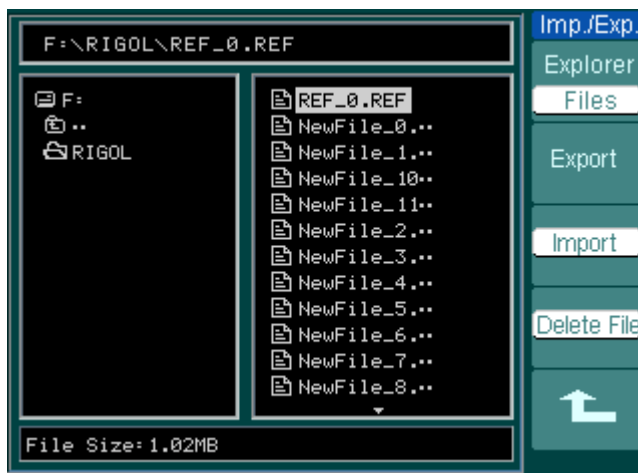

Figure 2- 21
Import /export interface

2. Export

Press **REF** → **Imp./Exp.** → **Export** to enter the following menu.

Figure 2- 22



Table 2- 11 The Export menu

Menu	Settings	Comments
↑		Move the cursor up
↓		Move the cursor down
X		To delete chosen letter
Save		Execute the operation



Figure 2- 23
Export interface

3. Save

Press **REF** → **Save** to enter the following menu.

Figure 2- 24 Table 2- 12 The Save Menu



Menu	Settings	Comments
Explorer	Path Directory File	Switch among Path, Directory and File
New File (Folder)		Set up new file in Path and File. Set up new folder in directory.
Delete File(Folder)		Delete file(Folder)

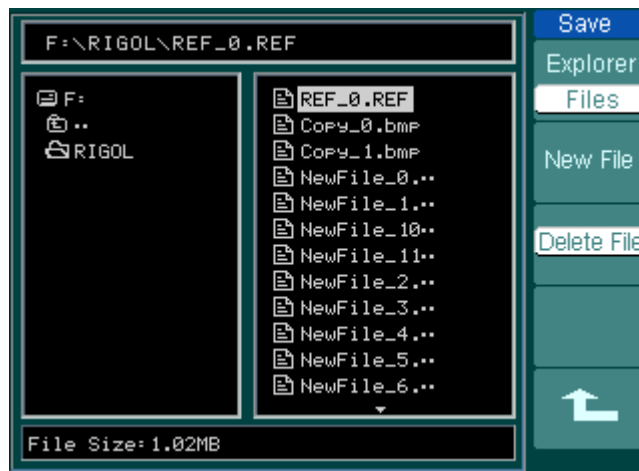

Figure 2- 25
Save interface

New File (or New Folder)

Press **REF** → **Save** → **New File** (or **New Folder**) and go to the following menu.

Figure 2- 26

Table 2- 13 The New File menu



Menu	Settings	Comments
↑		Move the cursor up
↓		Move the cursor down
✕		To delete chosen letter
Save		Execute the operation

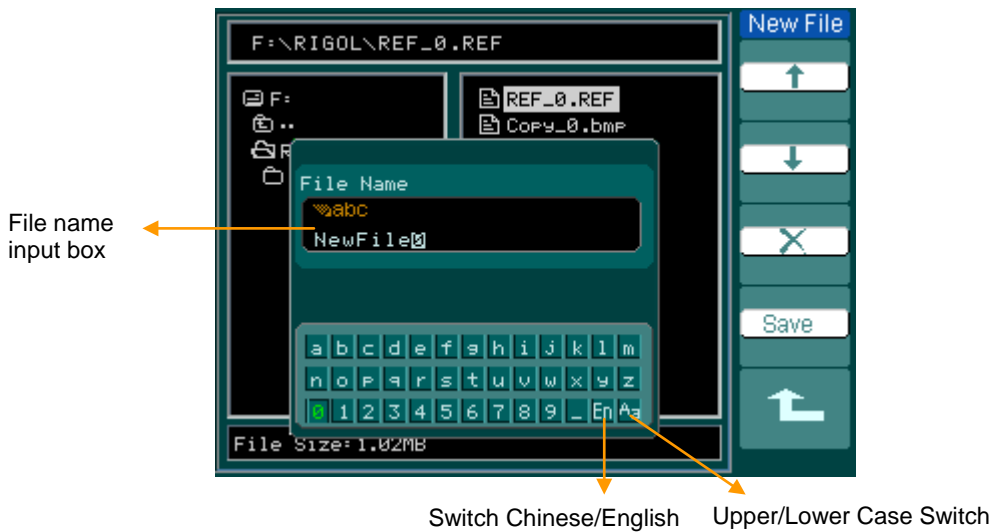

Figure 2- 27
Chinese Input interface

4. Import

Press **REF** → **Import** and go to the following menu.

Figure 2- 28



Table 2- 14 The Import menu

Menu	Settings	Comments
Explorer	Path Directory File	Switch among Path, Directory and File
Import		Import the REF file into internal memory

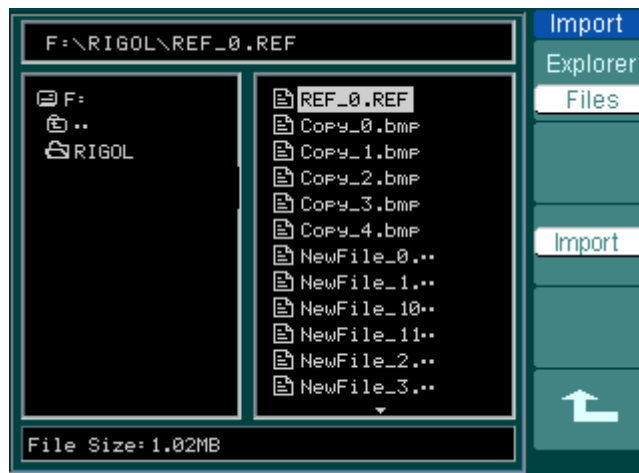

Figure 2- 29
Import interface

5. Displaying a Reference Waveform

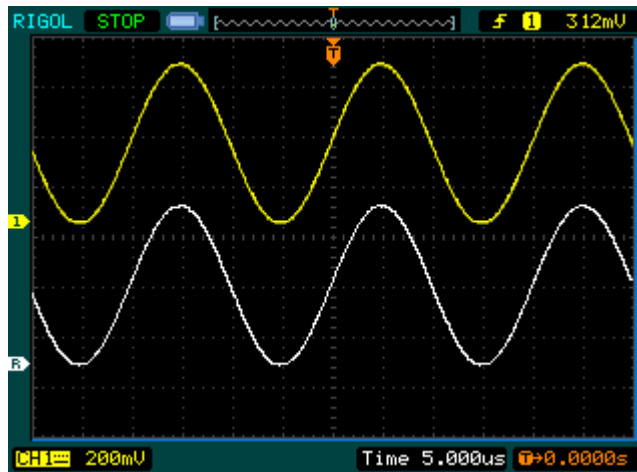

Figure 2- 30
Reference waveform display

1. Push **REF** button to show the reference waveform menu.
2. Press soft button No.1 to select the reference channel: **CH1**, **CH2**, **MATH**, **FFT** or **LA** (DS1000D series).
3. Turn vertical **POSITION** and vertical **SCALE** to adjust the REF waveform to a suitable position.
4. Press soft button No.2 to select the save location of REF waveform.
5. Press soft button No.3 to save the waveform as REF.

NOTE: The reference function is not available in X-Y mode.

Set up LA Channel (Only for DS1000D Series)

16 digital channels logical analyzer are provided for DS1000D series, which can achieve mixed-signal measure in line with the dual analog channels. Single channel or group channels can be chosen ON or OFF, and also can set the size of waveform. Change display location of digital channel on screen and select threshold type.

Press **LA** function button and go to the following menu.

Figure 2- 31 Table 2- 15 The LA menu

Menu	Settings	Comments
D7-D0	/	Set up channel group D7-D0 (see table 2-16)
D15-D8	/	set up channel group D15-D8 (see 2-17)
Current	↻ <D15-D0>	Select channel by turning (↻) knob
Threshold	TTL CMOS ECL User	Select mode of whole digital channels. The threshold voltage can set by user when in user-defined style.
User	↻ <Threshold Voltage>	Set threshold voltage by turning (↻) knob.

1. Display and re-line up the digital channels

- (1) Press **LA** → **D7-D0** or **D15-D8** and go to the group channel setting menu. Turn on or turn off the display of the digital channels.
- (2) Press **LA** → **current** and choose digital channel by turning (↻) knob. The chosen channel will display in red color.
- (3) Turn vertical **POSITION** knob to re-position the channel in screen.

The figure of menu shows as follow.

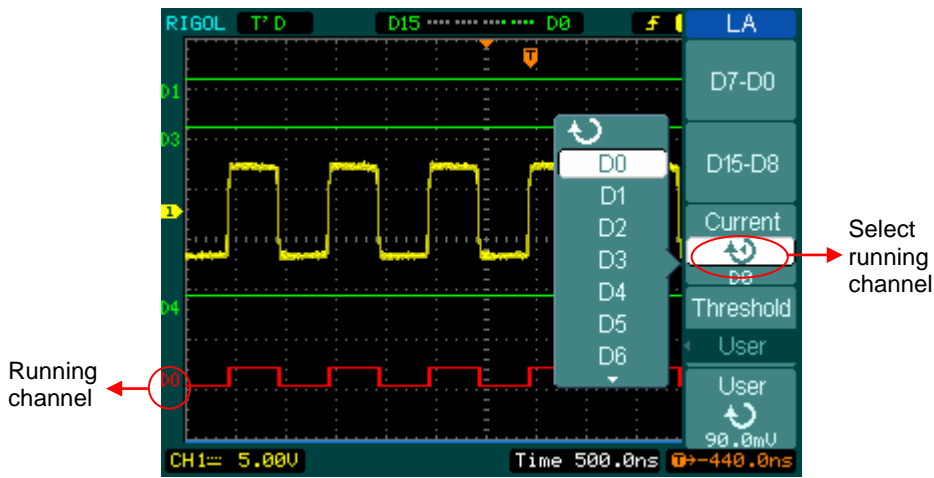

Figure 2- 32 Turn on the digital channel

2. Set threshold mode of digital channels

Press **LA** → **Threshold**, select logic standard or **User** to define your own threshold voltage. The figure of menu shows as follow.

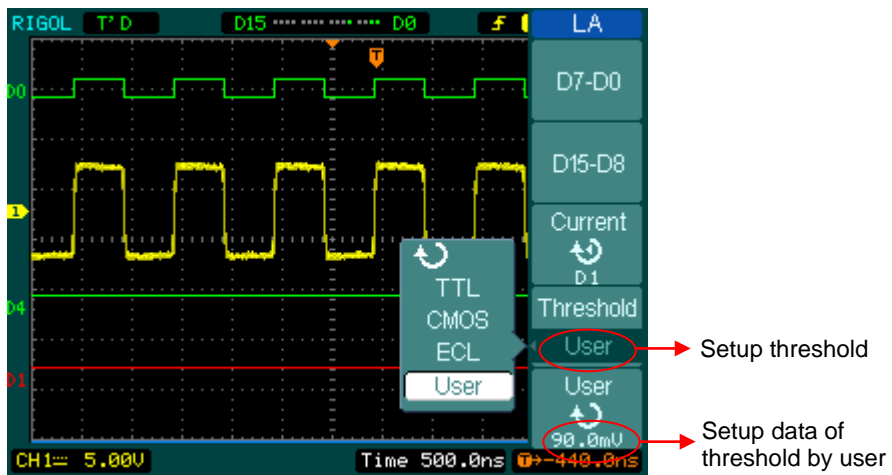

Figure 2- 33 Set the threshold

Threshold explanation

LOGIC STANDARD	TTL	CMOS	ECL	USER
THRESHOOLD VLOTAGE	1.4V	2.5V	-1.3V	-8V to 8V

Set up Channel Group

Press **LA** → **D7-D0** or **D15-D8**; Turn on/off the channel single, or in a group. Also you can change the size of waveforms in 8 bits as a group. See table 2-16 and 2-17.

Figure 2- 34 Table 2- 16 The Digital Channel menu (Page 1)

D7-D0	Channel	D7-D0	Turn Off	Size	Reset	↶
Menu	Settings	Comments				
channel	D7-D0	Turn on or off single channel of D7-D0				
D7-D0	Turn on Turn off	Turn on or off all 8 channels together				
Size	┌┐	Display 8 channels in a single screen				
	└┘	Display 16 channels in a single screen				
Reset		Reset waveform of channel D7-D0				

Figure 2- 35 Table 2- 17 The Digital Channel menu (Page 2)

D15-D8	Channel	D15-D8	Turn Off	Size	Reset	↶
Menu	Settings	Comments				
channel	D15-D8	Turn on or off single channel of D15-D8				
D15-D8	Turn on Turn off	Turn on or off 8 channels together				
Size	┌┐	Display 8 channels in a single screen				
	└┘	Display 16 channels in a single screen				
Reset		Reset waveform of channel D15-D8				

1. Turn on or off a digital channel

Press **[LA]** → **D7-D0** → **Channel**, and choose the wanted channel by turning (↻) knob.

Press No. 1 soft button or push down (↻) knob to turn on /off the channel. When the channel is on, we can see the mark (■). When the channel is turned off; the mark will display as (□).

As figure 2-36 shows.

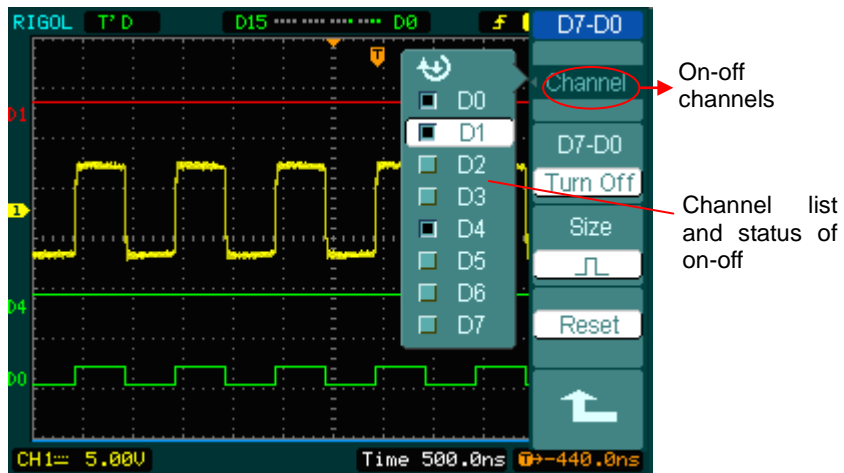

Figure 2- 36

Turn on or off the digital channel

2. Force turn on or off all digital channels

Press **[LA]** → **D7-D0** → **Turn On / Turn Off** (or **D15-D8** → **Turn On / Turn Off**) will force to turn all the channels on/off. If you want to turn on/off any single channel instead, select the **Channel** by turning (↻) knob, then press No. 1 soft button or (↻) knob.

3. Set up the viewing size of digital channels

Press **[LA]** → **D7-D0** → **Size**, or **D15-D8** → **Size**, to select wave size of logic channels.

Select **┌┐** to view 8 channels on the screen: Select **┌┐┌┐** to view all of the 16 channels on the screen.

4. Reset the digital channels display

Press **[LA]** → **D7-D0** → **Reset**, or **D15-D8** → **Reset** to reset the display of digital channels.

Turn on/off Channels

The CH1, CH2, Ext. Trigger and LA (DS1000D series) channels are input channels. All functionalities applied will be based on operating the instrument with channels. So MATH and REF can be regarded as relatively isolated channels.

To turn on/off any one of the channels, press the corresponding button on the front panel. The key backlight indicates the channel is currently active. Press the button again to turn the channel off. Or when channel is currently selected, press **OFF** will turn the channel off as well, and the key backlight also goes off.

The channel status symbol is displayed at the lower-left of the screen, which can help users to judge the channel status quickly.

Table 2- 18 Status of the channels

Channel Mode	Settings	Status Indicator
Channel 1 (CH1)	ON	CH1 (yellow letter)
	Selected	CH1 (black letter)
	OFF	No indicator
Channel 2 (CH2)	ON	CH2 (blue letter)
	Selected	CH2 (black letter)
	OFF	No indicator
MATH	ON	Math (purple letter)
	Selected	Math (black letter)
	OFF	No indicator

NOTE: Pressing **LA** will turn all the digital channels on/off.

Set up Vertical Position and Scale

You can use the vertical controls to display waveforms, adjust vertical **SCALE** and **POSITION**, and set input parameters.

1. Using vertical **POSITION** knob.
The vertical **POSITION** control changes the position of signal waveforms in all channels (including MATH and REF). The resolution changes according to the vertical level set. Pressing this knob will clear the channel offset to zero. (The function is available for DS1000D series, but not includes digital channel.)
2. Using vertical **SCALE** knob.
The vertical **SCALE** can change the vertical sensitivity of waveforms in all channels (including MATH and REF, excluding LA). If the Volts/Div is set to "Coarse", the waveform scales in a 1-2-5 step sequence from 2 mV to 5 V. If the Volts/Div is set to "Fine", it scales to small steps between the coarse settings.
3. Channels can be adjusted by the vertical **POSITION** and **SCALE** only when they are selected.
4. During the vertical position, a position message is displayed on the left bottom of the screen, in the same color as the corresponding channel. The unit is V (Volts).

To Set up the Horizontal System

The oscilloscope shows the time per division in the scale readout. Since all active waveforms use the same time base, the oscilloscope only displays one value for all the active channels, except when using Delayed Scan, or Alternate Trigger.

The horizontal controls can change the horizontal scale and position of waveforms. The horizontal center of the screen is the time reference for waveforms. Changing the horizontal scale causes the waveform to expand or contract about the screen center.

Horizontal position changes the displayed waveform position, relative to the trigger point. Press the horizontal **MENU** button to display the horizontal menu as follows.

Figure 2- 37 Table 2- 19 The Horizontal menu



Menu	Settings	Comments
Delayed	ON	Turn on Delayed Scan mode
	OFF	Turn off the Delayed Scan mode
Time Base	Y-T	Show the relative relation between vertical voltage and horizontal time.
	X-Y	Show CH1 value at X axis; CH2 value at Y axis.
	Roll	In Roll Mode, the waveform display updates from right to left.
Sa Rate		Show system sample rate
Trig-offset Reset		Adjust to the center

The parameter status symbol will be displayed on the screen during horizontal system settings, which can help users to judge the channel status quickly.

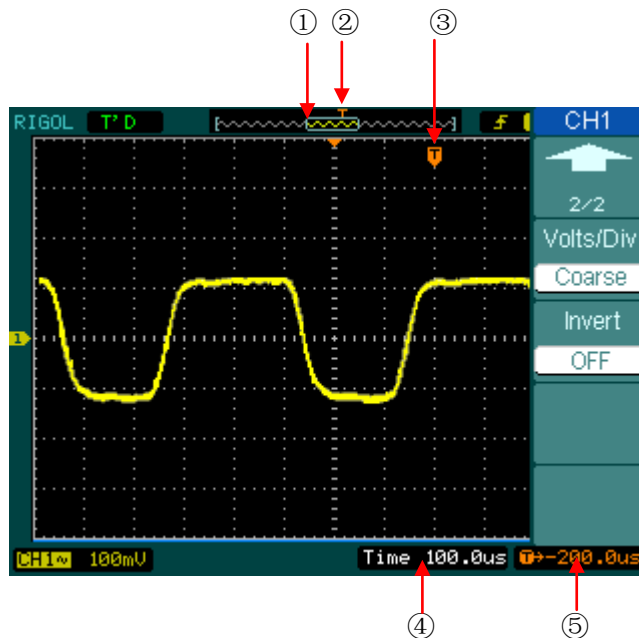

Figure 2- 38
Status bar and mark for Horizontal control

Marks Indicator:

- ① The position of current waveform window in the memory
- ② The trigger position in the memory.
- ③ The trigger position in the current waveform windows.
- ④ The horizontal time base (main time base).
- ⑤ The trigger's horizontal offset according to the center of the window.

Key Points

Y-T: The conventional oscilloscope display format. It shows the voltage of a waveform record (on the vertical axis) as it varies over time (on the horizontal axis).

X-Y: XY format displays channel 1 in the horizontal axis and channel 2 in the vertical axis.

Roll Mode: In this mode, the waveform display rolls from right to left. No trigger or horizontal offset control of waveforms is available during Roll Mode, and it's only available when set to 500 ms/div or slower.

Slow Scan Mode: This mode is available when the horizontal time base is set to 50ms/div or slower. In this mode, the oscilloscope acquires sufficient data for the left part to the trigger point, then wait for trigger, when trigger occurs, it continues to draw the rest part from the trigger point to the end of the right side. When choosing this mode to view low frequency signals, it is recommended that the channel coupling be set as DC.

Time/Div: Horizontal scale. The Time/Div control expands or compresses the waveform.

Delayed Scan

The Delayed Scan is a magnified portion of the main waveform window. Use Delayed Scan to locate and horizontally expand part of the main waveform window for a more detailed (higher horizontal resolution) analysis of signal. The Delayed Scan time base setting cannot be set slower than the Main time base setting.

Press horizontal **MENU** → Delayed → ON or press horizontal **SCALE** knob to enter Delayed Scan mode.

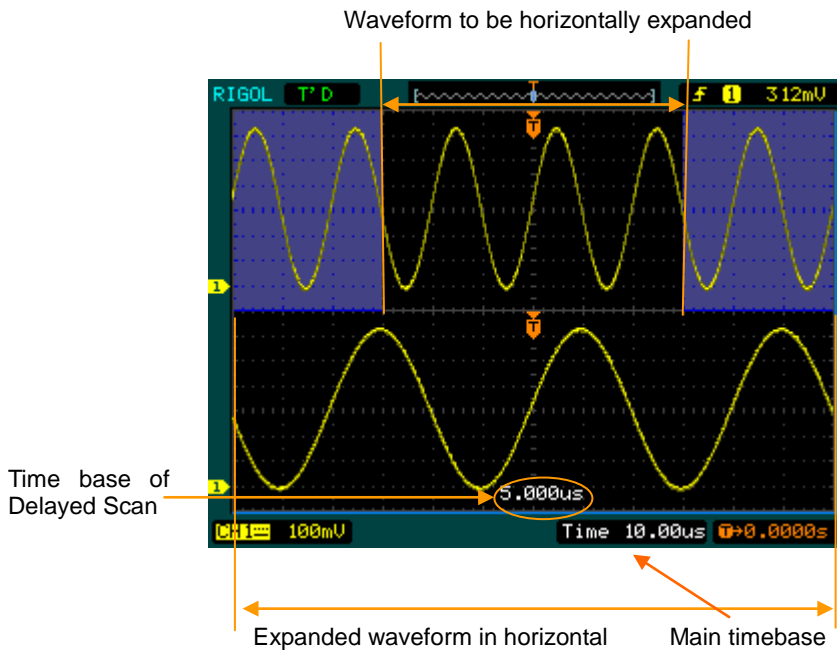





Figure 2- 39
Delayed Scan window

The screen splits into two parts.

The upper half displays the main waveform window and the lower half displays an expanded portion of the main waveform window. This expanded portion of the main window is called the Delayed Scan window. Two blocks shaded at the upper half; the un-shaded portion is expanded in the lower half. The horizontal **POSITION** and **SCALE** knobs control the size and position of the Delayed Scan. The value at bottom of the screen is the main time base and the value on the center bottom means the Delayed Scan time.

- Use the horizontal  POSITION knob to change the position of the expanded portion.
- Use the horizontal  SCALE knob to adjust the Delayed Scan resolution.
- To change the main time base, turn off the Delayed Scan mode.
- Since both the main and Delayed Scan are displayed; there are half as many vertical divisions so the vertical scaling is doubled. Notice the changes in the status bar.

Delayed Scan Shortcut Key:

Delayed Scan function can be activated not only by menu but also by pressing horizontal  SCALE knob.

X-Y Format

This format is useful for studying phase relationships between two signals. Channel 1 in the horizontal axis(X) and channel 2 in the vertical axis(Y), the oscilloscope uses a none-trigger acquisition mode, data is displayed as dots.

Press horizontal **MENU** → Time Base → X-Y to enter the X-Y mode.

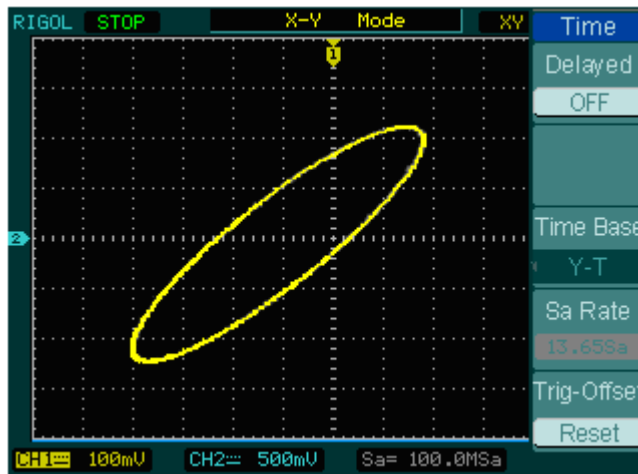



Figure 2- 40
X-Y display format

NOTE: In Y-T format, all sample rates are available. But in X-Y format, 100 MSa/s is not available. In common, decreasing the sample rate can display the waveform better.

The following modes or functions will not work in X-Y format.

- LA Function (DS1000D series)
- Automatic Measurements
- Cursor Measurements
- REF and MATH Operations
- Delayed Scan Mode
- Vector Display Mode
- Horizontal  POSITION knob
- Trigger Controls

The Horizontal Knobs

POSITION:

The horizontal  POSITION knob adjusts the horizontal position of all channels (including Math) waveforms. The resolution of this control varies with the time base. Pressing this button clears trigger offset and moves the trigger point to the horizontal center of the screen.

SCALE:

Use  SCALE to select the horizontal time/div (scale factor) for the main or the time base of Delayed Scan. When Delayed Scan is enabled, it changes the width of the window zone by changing the Delayed Scan time base.

To Set up the Trigger System

The trigger determines when the oscilloscope starts to acquire data and display a waveform. When a trigger is set up properly, it can convert unstable displays or blank screens into meaningful waveforms.

When the oscilloscope starts to acquire a waveform, it collects enough data so that it can draw the waveform to the left of the trigger point. The oscilloscope continues to acquire data while waiting for the trigger condition to occur. After it detects a trigger, the oscilloscope continues to acquire enough data so that it can draw the waveform to the right of the trigger point.

The trigger control area on the front panel includes a knob and three buttons:

- LEVEL**: The knob that set the trigger level; press the knob and the level will reset to zero.
- 50%**: The instant execute button setting the trigger level to the vertical midpoint between the peaks of the trigger signal
- FORCE**: Force to create a trigger signal and the function is mainly used in Normal and Single mode
- MENU**: The button that activates the trigger controls menu.

Press the Trigger **MENU** key to enter the trigger system setting interface.

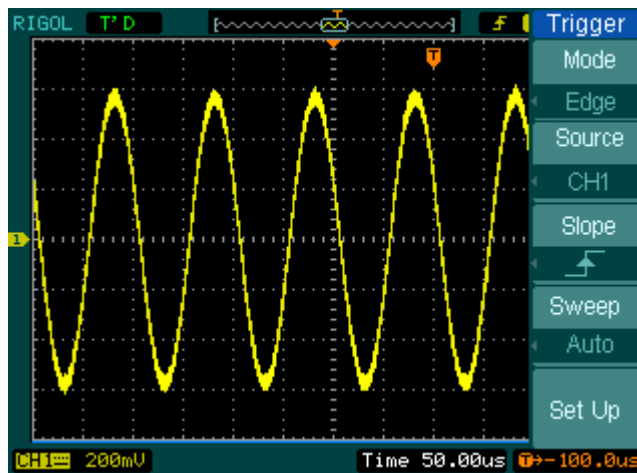

Figure 2- 41
Trigger controls interface

Trigger Modes

The oscilloscope provides seven trigger modes: Edge, Pulse Width, Slope, Video, Alternate, Pattern (only for DS1000D series) and Duration trigger (only for DS1000D series).

Edge: An edge trigger occurs when the trigger input passes through a specified voltage level at the specified slope direction.

Pulse Width: Use this trigger type to catch pulses with certain pulse width.

Slope: The oscilloscope begins to trigger according to the signal rising or falling speed.

Video: Use video trigger on fields or lines for standard video signals.

Alternate: Trigger on non-synchronized signals of the dual channels.

Pattern: To Trigger through detecting a specified code.

Duration: To trigger within a specified time on the conditions of a specified code.



Edge Trigger

Edge Trigger Mode; An edge trigger determines whether the oscilloscope finds the trigger point on the rising or the falling edge of a signal. Select Edge trigger Mode to trigger on Rising edge, falling edge or rising & falling edge.

Press Trigger **MENU** → **Mode** → **Edge** to display the edge trigger menu as follows.

Figure 2- 42 Table 2- 20 The Edge Trigger Menu



Menu	Settings	Comments
Source	CH1	Select CH1 as trigger signal
	CH2	Select CH2 as trigger signal
	EXT	Select EXT TRIG as trigger signal
	AC Line	Select power line as trigger signal
	D15-D0	Select a digital channel in D15-D0 as trigger source (for DS1000D series)
Slope	 Rising	Trigger on rising edge
	 Falling	Trigger on falling edge
	 Rising & Falling	Trigger on both ring & falling edge
Sweep	Auto	Acquire waveform even no trigger occurred
	Normal Single	Acquire waveform when trigger occurred. When trigger occurs, acquire one waveform then stop
Set up		To go to Set Up menu, see table 2-38

Pulse Width Trigger

Pulse Width Trigger Mode: Pulse trigger occurs according to the width of pulse. The abnormal signals can be detected through setting up the pulse width condition.

Press Trigger **MENU** → **Mode** → **Pulse** to display the pulse width trigger menu as follows.

Figure 2- 43 Table 2- 21 The Pulse Width Trigger Menu (page 1/2)









Menu	Settings	Comments
Source	CH1 CH2 EXT D15-D0	Selects CH1 as trigger signal Select CH2 as trigger signal Select EXT TRIG as trigger signal Select a digital channel in D15-D0 as trigger source(Only for DS1000D series)
When	 (+Pulse width less than)  (+Pulse width more than)  (+Pulse width equal to)  (-Pulse width less than)  (-Pulse width more than)  (-Pulse width equal to)	To select pulse condition
Settings	 <Width>	Set required pulse width

Figure 2- 44 Table 2- 22 The Pulse Width Trigger Menu (page 2/2)



Menu	Settings	Comments
Sweep	Auto Normal Single	Acquire waveform even no trigger occurred Acquire waveform when trigger occurred. When trigger occurs, acquire one waveform and then stop
Set Up		To go to Set Up menu, see table 2-38



NOTE: The Pulse width adjust range is 20ns ~ 10s. When the condition is met, it will trigger and acquire the waveform.

Slope Trigger

Slope Trigger Mode: Slope trigger sets the oscilloscope as the positive/negative slope trigger within the specified time. Press Trigger **MENU**→**Mode**→**Slope** to display the slope trigger menu as follows.

Figure 2- 45 Table 2- 23 The Slope Trigger Menu (Page 1/2)

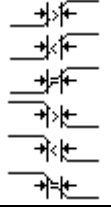



Menu	Settings	Comments
Source	CH1 CH2 EXT	Set channel 1 as trigger source Set channel 2 as trigger source Set EXT. channel as trigger source
When		To select the slope condition
Time ^[1]		To set slope time

NOTE^[1]:

Slope time can be set from 20ns to 10s. When a signal meets the trigger condition, The oscilloscope will execute the acquisition.

Figure 2- 46 Table 2- 24 The Slope Trigger Menu (Page2/2)

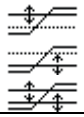

Menu	Settings	Comments
Vertical ^[2]		Select the level that can be adjusted by  LEVEL
Sweep	Auto Normal Single	Acquire waveform even when no trigger condition is met. Acquire waveform when trigger condition is met. When trigger condition is met, acquire one waveform and then stop
Set Up		To go to set up menu. See table 2-38

NOTE^[2]:

You can adjust LEVEL A/ LEVEL B or both simultaneous by turning the  LEVEL knob.

Video Trigger

Video Trigger Mode: Video trigger is used to capture the complicated waveforms of television. The trigger circuitry detects the vertical and horizontal interval of the waveform and produces triggers based on the video trigger settings you have selected. Choose video trigger to trigger on fields or lines of NTSC, PAL/SECAM standard video signals. Trigger coupling preset to DC.

Figure 2- 47 Table 2- 25 The Video Trigger Menu (Page 1/2)







Menu	Settings	Comments
Source	CH1 CH2 EXT	Selects CH1 as trigger source Select CH2 as trigger source Select EXT TRIG as trigger source
Polarity	 positive  negative	Triggers on positive going sync pulses Triggers on negative going sync pulses
Sync	All Lines	Trigger on all lines
	Line Num	Trigger on an specified line
	Odd field	Select to trigger on odd field
	Even field	Select to trigger on even field

Figure 2- 48 Table 2- 26 The Video Trigger menu (Page 2/2, Sync is line)



Menu	Settings	Comments
Line Num ^[1]	 < Line sync >	Select the specified line number for sync
Standard	PAL/SECM NTSC	Select Video standard
Sweep	Auto Normal Single	Acquire waveform even no trigger occurred Acquire waveform when trigger occurred. When trigger occurs, acquire one waveform and then stop
Set Up		To go to set up menu, see table 2-39

NOTE^[1]: The line number ranges can be set from 1 to 525 under NTSC standard, and from 1 to 625 under PAL/SECAM.

Figure 2- 49 Table 2- 27 The Video Menu (When the Sync is set as All lines, Odd field and Even field)



Menu	Settings	Comments
Standard	PAL/SECAM NTSC	Select Video standard
Sweep	Auto Normal Single	Acquire waveform even no trigger occurred Acquire waveform when trigger occurred. When trigger occurs, acquire one waveform and then stop
Set Up		To go to set up menu, see table 2-39

Key points

Sync Pulses: When positive polarity is selected, the trigger always occurs on negative-going sync pulses. If the video signal has positive-going sync pulses, use the negative polarity selection.

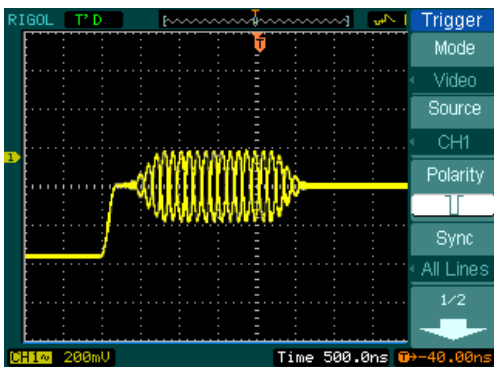

Figure 2- 50
Video Trigger: Line Synchronization

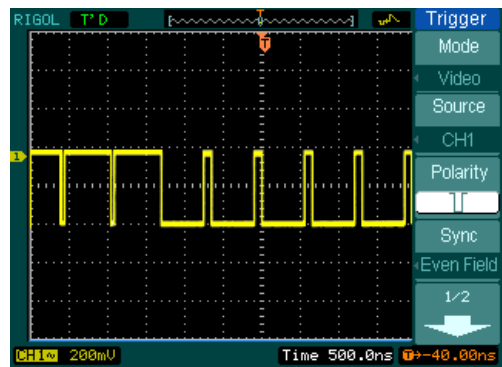



Figure 2- 51
Video Trigger: Field Synchronization

Alternate Trigger

Alternate Trigger Mode: When alternate trigger is on, the trigger sources come from two vertical channels. This mode can be used to observe two non-related signals. You can choose two different trigger modes for the two vertical channels. The options are as follows: Edge, Pulse, Slope and video. The information of the trigger level of the two channels will be displayed on the upper-right of the screen.

Press Trigger **MENU**→**Mode**→**Alternate** to display the alternate trigger menu as follows.

Figure 2- 52 Table 2- 28 The Alternate menu (Trigger Type: Edge)



Menu	Settings	Comments
Select	CH1 CH2	Set trigger mode for Channel 1 Set trigger mode for Channel 2
Type	Edge	Set Edge Trigger as the trigger type
Slope	↗ (Rising) ↘ (Falling)	Trigger on rising edge Trigger on falling edge
Set Up	/	
		To go to set up menu. See table 2-38

Figure 2- 53 Table 2- 29 (Trigger Type: Pulse, Page 1/2)



Menu	Settings	Comments
Select	CH1 CH2	Set trigger mode for Channel 1 Set trigger mode for Channel 2
Type	Pulse	Set Pulse Trigger for the channel
When	↗↘ (+Pulse width less than) ↗↘ (>) (+Pulse width more than) ↗↘ (=) (+Pulse width equal to) ↘↗ (-Pulse width less than) ↘↗ (>) (-Pulse width more than) ↘↗ (=) (-Pulse width equal to)	To select pulse condition

Figure 2- 54 Table 2- 30 The Alternate menu (Trigger Type: Pulse, Page 2/2)



Menu	Settings	Comments
Setting	 <pulse width>	Set the width of the pulse
Set Up		To go to set up menu. See table 2-38

Figure 2- 55 Table 2- 31 The Alternate menu (Trigger Type: Slope, Page 1/2)



Menu	Settings	Comments
Select	CH1 CH2	Set trigger mode for Channel 1 Set trigger mode for Channel 2
Type	Slope	Set Slope Trigger for the vertical channel
When		Set trigger condition

Figure 2- 56 Table 2- 32 The Alternate menu (Trigger Type: Slope Page 2/2)



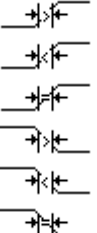

Menu	Settings	Comments
Time	 <Time Set >	Set slope time
Vertical		Select the level to be adjusted by <input checked="" type="radio"/> LEVEL
Set Up		To go to set up menu. See table 2-38

Figure 2- 57 Table 2- 33 The Alternate menu (Trigger Type: Video, Page 1/2)



Trigger	Mode	Alternative	Select	CH1	Type	Video	Polarity	1/2	↓
Menu	Settings	Comments							
Select	CH1 CH2	Set trigger mode for Channel 1 Set trigger mode for Channel 2							
Type	Video	Video Trigger for the channel							
Polarity	 positive  negative	Triggers on positive going sync pulses Triggers on negative going sync pulses							

Figure 2- 58 Table 2- 34 The Alternate menu (Video, Line Num Page 2/2)

Trigger	↑	2/2	Sync	Line Num	Line Num	↺	No. 1	Standard	NTSC	Set Up
Menu	Settings	Comments								
Sync	ALL lines	Trigger on all lines								
	Line Num	Trigger on an specified line								
Line Num	Odd field	Select to trigger on odd field or even field								
	Even field									
Line Num	 <Lines Set >	Select the specified line number for sync								
Standard	PAL/SECM NTSC	Select Video standard								
Set Up	/	To go to set up menu, see table 2-39								

Figure 2- 59 Table 2- 35 The Alternate menu (Trigger Mode: Video, All Lines, Odd Field or Even Filed, Page 2/2)





Menu	Settings	Comments
Sync	ALL lines	Trigger on all lines
	Line Num	Trigger on an specified line
Standard	Odd field	Select to trigger on odd field or even field
	Even field	
Standard	PAL/SECM NTSC	Select Video standard
Set Up	/	To go to set up menu, see table 2-39



Pattern Trigger (Only for DS1000D Series)

Pattern Trigger Mode: Pattern trigger identifies trigger terms by checking appointed code. The code is logical relationship of all channels, with high (H), low (L) and ignore(X). Press Trigger **MENU**→**Mode**→**Pattern** to display the pattern trigger menu as follows.

Figure 2- 60 Table 2- 36 The Pattern Trigger Menu

Menu	Settings	Comments
Select	D15-D0	Choose digital channel for Pattern trigger
Code	H L X  	High Low Ignore Rising Edge Falling Edge
Sweep	Auto Normal Single	Acquire waveform even no trigger occurred Acquire waveform when trigger occurred When trigger occurs, acquire one waveform and then stop
Set Up		To go to set up menu, see table 2-40

Key Points:

- H (High):** Logic high: voltage is higher than threshold setting.
- L (Low):** Logic low: voltage is lower than threshold setting.
- X (Ignore):** Don't care. If all the channels are ignored, the oscilloscope won't be triggered.
- Rising Edge () or Falling Edge (

Edge of appointed code**

You can only appoint one code as edge. If you have appointed an edge, then appointed another edge in a different channel, and the first appointed edge will be set to X (Ignore).

Duration Trigger (Only for DS1000D Series)

Duration Trigger Mode: Trigger in appointed time when code terms are satisfied. Press Trigger **MENU** → **Mode** → **Duration** to display the duration trigger menu as follows.

Figure 2- 61 Table 2- 37 The Duration Trigger Menu (Page 1/2)



Menu	Settings	Comments
Select	D15-D0	Choose digital channel for Duration Trigger
Code	H	High
	L	Low
	X	Ignore
Qualifier	<	Set time limit terms
	>	
	=	

Figure 2- 62 Table 2- 38 The Duration Trigger Menu (Page 2/2)



Menu	Settings	Comments
Time	↻ <Time Setting>	Set duration and limit symbol time
Sweep	Auto	Acquire waveform even no trigger occurred
	Normal	Acquire waveform when trigger occurred
	Single	When trigger occurs, acquire one waveform and then stop
Set Up		To go to set up menu, see table 2-40

Key Points:

- H (High):** Logic high: voltage is higher than threshold setting.
- L (Low):** Logic low: voltage is lower than threshold setting.
- X (Ignore):** Don't care. If all the channels are ignored, the oscilloscope won't be triggered.
- Qualifier:** A timer begins when code terms are satisfied. Duration trigger occurred in the time set by the qualifier.

Trigger Setup

Set up different trigger settings according to different trigger modes. When choosing source as D15-D0 in the mode of Edge and Pulse (DS1000D series), only Holdoff is adjustable. When source is non-digital channel and in slope trigger, only trigger coupling, trigger sensitivity and Holdoff can be set. For video trigger, Sensitivity and Holdoff can be set. For the pattern trigger and the duration trigger (DS1000D series), only Holdoff is adjustable.

Figure 2- 63 Table 2- 39 The Trigger Set Up Menu (Settings for trigger coupling, trigger sensitivity and holdoff)



Menu	Settings	Comments
Coupling	DC AC HF Reject LF Reject	Allow all signals pass Block DC signals Reject high frequency signals Reject DC and low frequency signals
Sensitivity	↻ <Sensitivity Setting>	Set trigger sensitivity, the range is from 0.1div to 1div
Holdoff	↻ <Holdoff Setting>	Set time slot before another trigger event, the range is from 500ns to 1.5s
Holdoff	Reset	Reset Holdoff time to 500ns

Figure 2- 64 Table 2- 40 The Trigger Set Up Menu (Settings for sensitivity and holdoff)



Menu	Settings	Comments
Sensitivity	↻ <Sensitivity Setting>	Set trigger sensitivity
Holdoff	<Holdoff Setting>	Set time slot before another trigger event
Holdoff	Reset	Reset Holdoff time to 500ns

Figure 2- 65 Table 2- 41 The Trigger Set Up Menu (Settings only for holdoff)



Menu	Settings	Comments
Holdoff	↻ <Holdoff Setting>	Set time slot before another trigger event
Holdoff	Reset	Reset Holdoff time to 500ns

Trigger Holdoff

Trigger Holdoff can stabilize complex waveform, such as the pulse range. Holdoff time is the oscilloscope's waiting period before starting a new trigger. During Holdoff, oscilloscope will not trigger until Holdoff ends. For instance: To trigger on the first pulse on a group of them, users can set the holdoff time to Pulse cluster width.

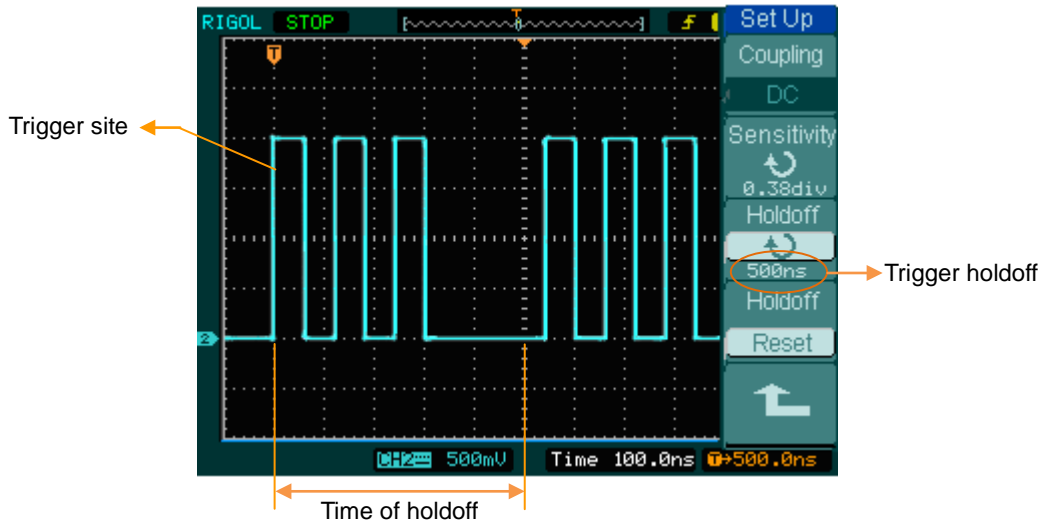

Figure 2- 66 Trigger Holdoff display

To use trigger Holdoff:

1. Press the trigger **MENU** key to display Trigger Menu.
2. Press **Set Up** key to display trigger set up menu.
3. Turn the multi function knob (⤵) to change Holdoff time until waveform is stable.
4. Press **Reset** can reset the Holdoff time to its default value.

Trigger Key points

1. **Trigger Source:** Trigger can occur from several sources: Input channels (CH1 and CH2), AC Line, Ext.
 - **CH1 or CH2:** It is the most commonly used trigger source. The channel works when selected as a trigger source whatever displayed or not.
 - **Ext Trig:** The instrument can be triggered from a third source while acquiring data from CH1 and CH2. For example, to trigger from an external clock or with a signal from another part of the test circuit. The Ext trigger sources use an external trigger signal connected to the EXT TRIG connector. Ext uses the signal directly; it has a trigger level range of -1.2V to +1.2V.
 - **AC Line:** AC power can be used to display signals related to the power line frequency, such as lighting equipment and power supply devices. The oscilloscope gets triggered on its AC power input; an AC trigger signal is not required. When AC Line is selected as trigger source, the oscilloscope automatically set coupling to DC, set trigger level to 0V.
2. **Sweep Mode:** The sweep mode determines how the oscilloscope behaves in the absence of a trigger event. The oscilloscope provides three trigger modes: Auto, Normal, and Single.
 - **Auto:** This sweep mode allows the oscilloscope to acquire waveforms even when it does not detect a trigger condition. If no trigger condition occurs while the oscilloscope is waiting for a specific period (as determined by the time-base setting), it will force itself to trigger.

When forcing invalid triggers, the oscilloscope cannot synchronize the waveform, and the waveform seems to roll across the display. If valid triggers occur, the display becomes stable on the screen.

Any factor results in the un-stability of waveforms can be detected by Auto Trigger, such as the output of Power supply.

NOTE: When horizontal control is set under 50 ms/div, Auto mode allows the oscilloscope not to capture trigger signal.

- **Normal:** The Normal mode allows the oscilloscope to acquire a waveform only when it is triggered. If no trigger occurs, the oscilloscope keeps waiting, and the

previous waveform, if any, will remain on the display.

- **Single:** In Single mode, after pressing the RUN/STOP key, the oscilloscope waits for trigger. While the trigger occurs, the oscilloscope acquires one waveform then stop.
3. **Coupling:** Trigger coupling determines which signal component passing to the trigger circuit. Coupling types include AC, DC, LF Reject and HF Reject.
- **AC:** AC coupling blocks DC components and attenuates the signal below 10Hz.
 - **DC:** DC coupling passes both AC and DC components.
 - **LF Reject:** LF Reject coupling blocks DC component, and attenuates all signal with a frequency lower than 8 kHz.
 - **HF Reject:** HF Reject coupling attenuates all signals with a frequency higher than 150 kHz.
4. **Pre-trigger/delayed trigger:** The data collected before and after trigger. The trigger position is typically set at the horizontal center of the screen. In the full-screen display the 6div data of pre-trigger and delayed trigger can be surveyed. More data of pre-trigger and 1s delayed trigger can be surveyed by adjusting the horizontal  **POSITION** knob.

This feature is very useful to study the events that led up to the trigger point. Everything to the right of the trigger point is called post-trigger information. The delay range (pre-trigger and post-trigger information) depends on the sweep speed selected.

5. **Adjustable trigger sensitivity:** To avoid the influence of noise from the physical world, and get the stable trigger, the trigger circuit has adopted Stickiness. In DS1000E, DS1000D series, the stickiness is adjustable from 0.1div-1.0div, which means when it sets to 1.0div, the trigger circuit will not affect any signal with peak-peak amplitude less than 1.0div, so as to avoid the influence of the noise.

To Set up the Sampling System

Acquire shows the menu button for the acquire system on the front panel.

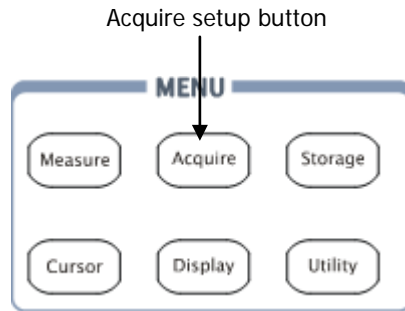

Figure 2- 67

Acquire setup button

Press the **Acquire** button, the interface menu as follows:

Figure 2- 68 Table 2- 42 The Acquire menu



Menu	Settings	Comments
Acquisition	Normal Average Peak Detect	Normal Acquisition mode Average Acquisition mode Peak Detect Acquisition mode
Averages ^[1]	2 to 256	Step by 2 times the power of N. Set average times from 2 to 256
Sampling	Real-Time Equ-Time	Real-time sampling mode Equivalent sampling mode
Mem Depth	Long Mem Normal	Set up memory as 512kpts or 1Mpts Set up memory as 8kpts or 16kpts
Sinx/x ^[2]	ON OFF	Set the insert mode to sinx/x Set the insert mode to line

NOTE^[1]: This function is used in "Average Acquisition";

NOTE^[2]: This function is used in "Real Time" sampling.

The waveform display will be different when selecting different acquisition and sampling:

- Select **Real-time** acquisition to observe the single-shot or pulse signals.
- Select **Equ-Time** to observe high frequency repetitive signals.
- To reduce the displayed random noise, select **Average** Acquisition. And this mode would make the screen refresh slower.
- To Avoid signal aliasing, select **Peak Detect** Acquisition.

The waveform displayed on the screen will change in conjunction with the setting of Acquire menu.

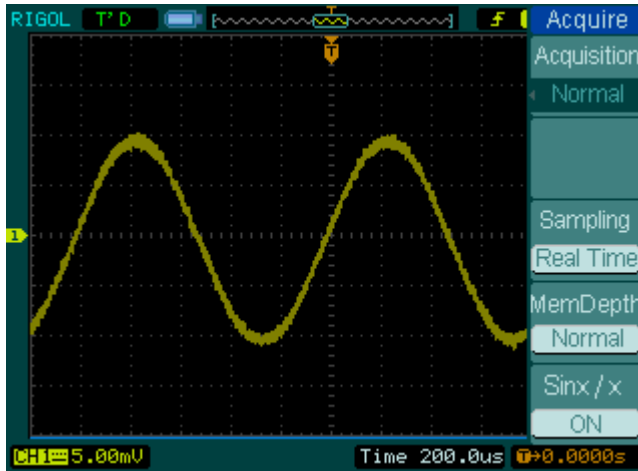

Figure 2- 69

Signal that contains noise, and without average sampling

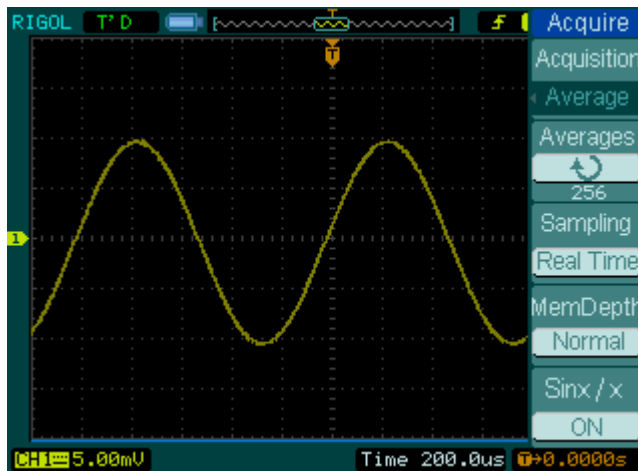

Figure 2- 70

Display signal after average sampling

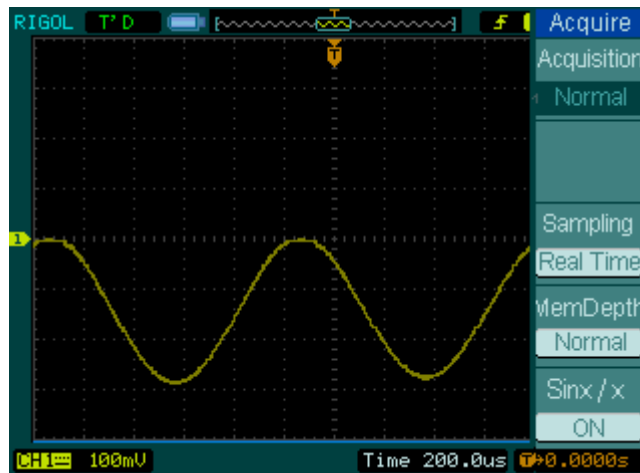

Figure 2- 71
Signal without Peak Detect Acquisition

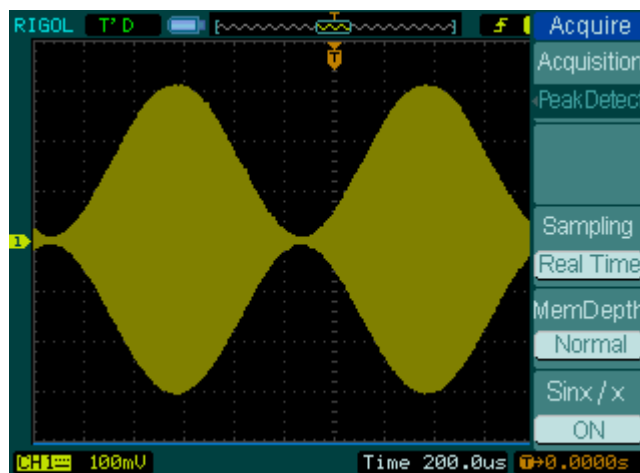

Figure 2- 72
Signal with Peak Detect Acquisition

Stop Acquisition: When the scope is acquiring waveforms, the waveforms is in a live status; when acquisition is stopped, frozen waveform will be displayed, the position and scale can still be adjusted by vertical control and horizontal control.

Key Points

Real-time Sampling: The oscilloscope has Real-time sampling rate up to 1GSa/s. At the time base 50ns or faster, the oscilloscopes use the sine(x)/x interpolation to expand the horizontal time base.

Equivalent Sampling: Known as Repetitive sampling to get up to 40ps of horizontal resolution (equivalent 25Gsa/s). This mode is good for observing repetitive signals, and it is not recommended for single-shot or pulse.

Normal Acquisition: Oscilloscope acquires signal by equal time interval.

Average Acquisition: Apply averaging to your signal to remove uncorrelated noise and improve measurement accuracy. Reduces random or uncorrelated noise in the signal display. The averaged waveform is a running average over a specified number of acquisitions from 2 to 256.

Peak Detect Acquisition: Peak Detect mode captures the maximum and minimum values of a signal. Finds highest and lowest record points over many acquisitions.

To Set up the Display System

Display shows the menu button for the display system on the front panel.

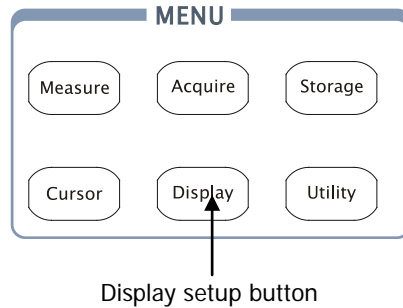

Figure 2- 73

Display setup button

Press the **Display** button to pop up the menu for the settings of the display system.

Figure 2- 74 Table 2- 43 The Display menu (Page 1/2)







Menu	Setting	Comments
Type	Vectors Dots	Display waveforms as vectors Display waveforms as dots
Clear		Clear all existing waveforms from screen
persist	Infinite	The sample points remain displayed until turn the persistence "OFF".
	OFF	Turn off the persistence function
Intensity	 <percentage >	Set up waveform intensity, the range is from 0% to 100%

Figure 2- 75 Table 2- 44 The Display menu (Page 2/2)



Menu	Settings	Comments
Grid	  	Display grids and coordinates on the screen Turn off the grids Turn off the grids and coordinates
Brightness	 < percentage >	Set up grid brightness
Menu Display	1s 2s 5s 10s 20s Infinite	Set the time before menu fades away. The menu will be hidden after the set time of last button pressing.

Key points:

- 1. Display type:** Display type includes Vector and Dot. In vectors type, the oscilloscopes connect dots through digital interpolation including both linearity and $\sin(x)/x$. $\sin(x)/x$ interpolation is suitable for Real-time sampling and will be more effective at 50ns or faster time base.
- 2. Refresh rate:** It is an important performance of digital oscilloscopes. It means the number of display refreshing per second and it will affect the ability to observe signal.

Adjusting waveform intensity

Default setup of multi-function knob () is adjusting waveform intensity.

To Store and Recall

Storage shows the menu button for the storage system on the front panel.

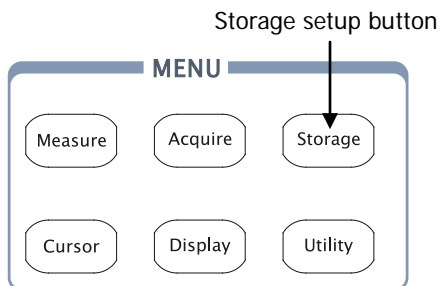

Figure 2- 76
Storage setup button

Press the **Storage** button to show the menu for the settings of the storage system. Waveforms and setups can be stored in and recalled from, both internal memory and external memory. The waveform file, setup file, bitmap and CSV file in external memory can be created and deleted (Note: internal file can be deleted or overwritten). System supports English/Chinese key in.

Waveform and setup, the menu as following:

Figure 2- 77 Table 2- 45 The Storage menu (For Waveform and Setups)

Storage
Storage
Waveform
Internal
External
Disk Mana.

Menu	Settings	Comments
Storage	Waveform Setups	Store or recall waveform or instrument setups
Internal		Go to menu for internal memory operation (see table 2-48)
External		Go to menu for external memory operation (see table 2-49)
Disk Mana.		Go to disk manage menu (see table 2-50)

Figure 2- 78 Table 2- 46 The Storage menu (For Bitmap)



Menu	Settings	Comments
Storage	Bit map	Create or delete bit map files
Para Save	ON OFF	Save the current oscilloscope settings in different format with the same file name
External		Go to menu for external memory operation(see table 2-49)
Disk Mana.		Go to disk manage menu (see table 2-50)

Figure 2- 79 Table 2- 47 The Storage menu (For CSV)



Menu	Settings	Comments
Storage	CSV	Create or delete CSV files
Data Depth	Displayed Maximum	Save currently displayed waveform data to CSV file Save the whole waveform data in memory to CSV file
Para Save	On Off	Save the current oscilloscope settings in different format with the same file name
LA Data Type ^[1]	Hex Decimal Binary	Save data in hexadecimal format Save data in decimal format Save data in binary format
External		Go to menu for external memory operation (see table 2-49)
Disk Manage		Go to disk manage menu (see table 2-50)

NOTE^[1] : Applicable to DS1000D Series only.

Figure 2- 80 Table 2- 48 The Storage menu (For factory)



Menu	Settings	Comments
Storage	Factory	Recall factory setups
Load		Recall factory setups or files
Disk Mana.		Go to disk manage menu (see table 2-50)

Internal Memory

Press **Storage** → **Internal** to enter the following menu.

Figure 2- 81 Table 2- 49 The Internal Memory Menu



Menu	Settings	Comments
Internal	Int_00 (S) . . . Int_09 (N)	Set up the location of files in internal memory
Load		Recall waveform files and setup files from the internal memory location
Save		Save waveform files and setup files to the internal memory location
Delete File (Folder)		Delete the selected location file (folder)

External Memory

Press **Storage** → **External** to enter the following menu.

Figure 2- 82 Table 2- 50 The Memory menu

Menu	Settings	Comments
Explorer	Path Directory File	Switch among Path, Directory and File
New File (Folder)		To create new file or folder.
Delete File (Folder)		Delete the selected location file (folder)
Load		Recall waveform and setup from USB storage device.



Figure 2- 83
File system display

Disk Manage

Press **Storage** → **Disk Mana** to display the following menu.

Figure 2- 84 Table 2- 51 The Disk Manage Menu (Page 1/2)



Menu	Settings	Comments
Explorer	Path Directory File	Switch among Path, Directory and File
New folder		To create new folder(same as new files, see table 2-13)
Delete File		Delete file
Load		Recall waveform, setup, recorded waveform, Pass/Fail file

Figure 2- 85 Table 2- 52 The Disk Manage Menu (Page 2/2)



Menu	Settings	Comments
Rename		To rename a file (see table 2-52)
Disk info		Display disk information

Rename

Press **Storage** → **Disk Manage.** → **Rename** to go to the following menu.

Figure 2- 86



Table 2- 53 The Rename Menu

Menu	Settings	Comments
↑		To move the cursor up
↓		To move the cursor down
X		To delete chosen letter
OK		Rename the file

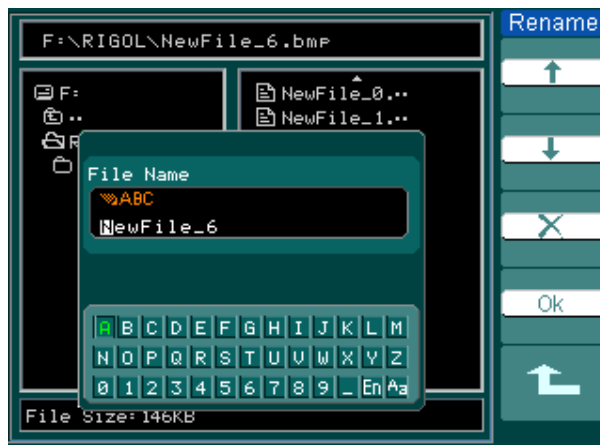

Figure 2- 87
Rename the file

Key Points:

Factory: The oscilloscope has default settings and can be recalled at anytime.

Memory location: Specify memory location to save/recall the waves and setups.

Load: Recall saved waveforms, setups and default settings.

Save: Save waveforms and setups.

NOTE:

1. Select **Save** stores not only the waveforms, but also the current settings.
2. To ensure the setups being saved properly, only after the settings are changed for more than 5 seconds can the user turn off the instrument. The oscilloscope can store 10 settings permanently and can restore at anytime.

To Set up the Utility System

Utility shows the menu button for the Utility on the front panel.

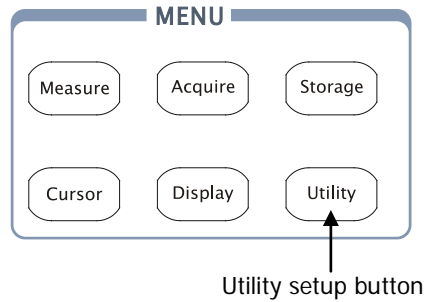

Figure 2- 88
Utility setup button

Press the **Utility** button to pop up the menu for the settings of the Utility system.

Figure 2- 89 Table 2- 54 The Utility Menu (Page 1/3)



Menu	Setting	Comments
I/O setting		Setup I/O configuration
Sound	(ON) (OFF)	Switch beeper sound on/off
Counter	OFF ON	Turn off Frequency Counter Turn on Frequency Counter
Language	简体中文 繁体中文 English 日本語 François ...	Select languages (More languages may be added in later firmware versions)

Figure 2- 90 Table 2- 55 The Utility menu (Page 2/3)



Menu	Settings	Comments
Pass/Fail		Setup Pass/Fail test
Record		Setup Waveform Recorder
Print set		Setup printing

Figure 2- 91 Table 2- 56 The Utility menu (Page 3/3)



Menu	Settings	Comments
Preference		Go to preference menu
Self-Cal		Execute Self-calibration
System Info		Display system information
Special Mode	Lock/Unlock	Lock the keyboard

NOTE:

Self-Calibration: Oscilloscope will calibrate parameter of vertical system (CH1, CH2, and Ext), horizontal system and trigger system.

I/O setting

Press **Utility** → **I/O setting** to go to the following menu.

Figure 2- 92 Table 2- 57 The I/O Setup Menu



Menu	Display	Comments
RS-232 Baud	300 . . 38400	Set RS-232 baud rate as 300, 2400, 4800, 9600, 19200 or 38400.
USB Device ^[1]	Computer PictBridge	Set the USB device
GPIB#	0-30	Set the GPIB address

NOTE^[1]: Users must set the **USB device** type manually first to ensure the equipment connected is the same as the settings when switch the device from computer (PictBridge printer) to PictBridge printer (computer) by the USB Device port.

Language

The oscilloscopes have multi-language user menu, choose as your desire.

Press **Utility** → **Language** to select the language.

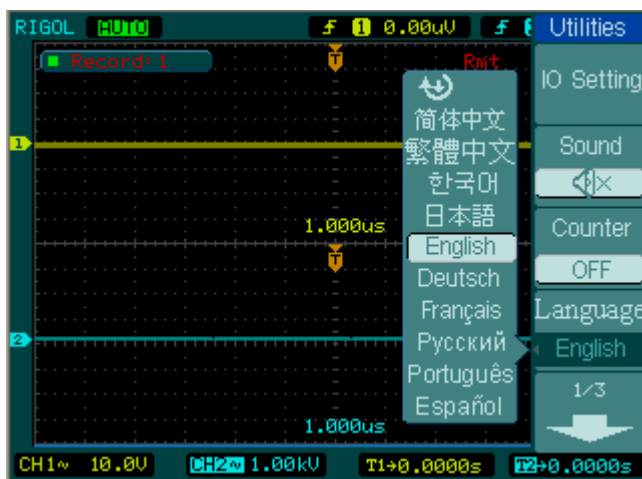



Figure 2- 93
The Language menu

Please use the fourth menu button or use the knob  to select the language you need.

Pass/Fail

The Pass/Fail function monitors changes of signals and output pass or fail signals by comparing the input signal that is within the pre-defined mask. The testing results not only can be displayed on screen or output by isolated pass/fail port but also can be alarmed if turn on system sound.

Press **Utility** → **Pass/Fail** to go to the following menu.

Figure 2- 94 Table 2- 58 The Pass/Fail Menu (Page 1/2)



Menu	Setting	Comments
Enable Test	ON OFF	Turn on Pass/Fail test Turn off Pass/Fail test
Source	CH1 CH2	Select Pass/Fail test on CH1 Select Pass/Fail test on CH2
Operate	▶ (RUN) ■ (STOP)	Pass/Fail test stopped, press to run Pass/Fail test running, press to stop
Msg display	ON OFF	Turn on Pass/Fail information display Turn off Pass/Fail information display

Figure 2- 95 Table 2- 59 The Pass/Fail Menu (Page 2/2)



Menu	Settings	Comments
Output	Fail Fail + 🔊 ^[1] Pass Pass + 🔊	Output when Fail condition detected. Output and beep when Fail condition detected. Output when Pass condition detected. Output and beep when Pass condition detected.
Stop on Output	ON OFF	Stop test when output occur Continue test when output occur
Mask Setting		Go to mask setting menu

NOTE^[1]: The beeper should be opened.

Mask Setting

Users can create, save, load and import/export the Pass/Fail mask by this function.

Press **Utility** → **Pass/Fail** → **Mask Setting** to go to the following menu.

Figure 2- 96 Table 2- 60 The Mask setting menu (Page 1/2)



Menu	Settings	Comments
X Mask	< x div >	Set horizontal clearance to the waveform (0.04div-4.00div)
Y Mask	< y div >	Set vertical clearance to the waveform (0.04div-4.00div)
Create Mask		Create a test mask according to the above clearance
Location	Internal External	Set the memory location of the mask files.

Figure 2- 97 Table 2- 61 The Mask setting menu (Page 2/2)

When the save as Internal memory



Menu	Settings	Comments
Save		Store created test mask into internal memory
Load		Recall mask setting file from internal memory
Imp./Exp.		Go to import/export menu (same as REF import/export menu. See table 2-10)

Figure 2- 98 Table 2- 62 The Mask setting menu (Page 2/2)



When the save as external memory

Menu	Settings	Comments
Save		Go to save menu (same as REF save menu. See table 2-12)
Load		Go to load menu see table 2-63
Import		Go to import menu. (same as REF import menu see table 2-14)

Load

Press **Utility** → **Pass/Fail** → **Mask Setting** → **Load** to enter the following menu.

Figure 2- 99 Table 2- 63 The Load menu



Menu	Settings	Comments
Explorer	Path Directory File	Switch among Path, Directory and File
Load		Recall the specified file

NOTE: Pass/Fail function is unavailable in X-Y mode.

Pass/Fail connection

In Pass/Fail testing output circuit, the Oscilloscope adopts the technique of Optical Isolation. It needs to connect to another circuit to fulfill the function. Before connecting to an external circuit, make sure the maximum voltage/current does not exceed 400V/100mA. The output device has no polarity limit and can be connect arbitrarily.

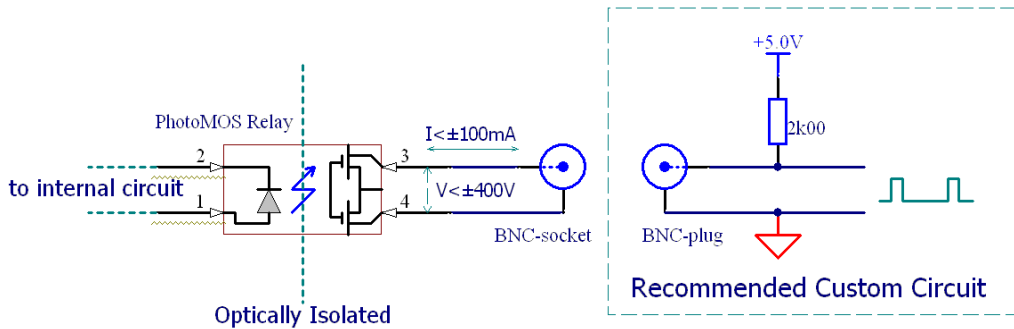

Figure 2- 100
Schematic Diagram of Pass/Fail output

Record

Waveform recorder records input waveforms from CH1 and CH2, with a maximum record length of 1000 frames. This performance can also be activated by the Pass/Fail test output, which makes this function especially useful to capture abnormal signals in long term without keeping an eye watching it. This function contains four modes: OFF, Record, Play back and Storage. More details about the function please refer to the following introduction.

1. **OFF:** It will close all record functions.
2. **Record:** To record waveform by selected time interval till the last frame.

Press **Utility** → **Record** → **Mode** → **Record** to go to the following menu.

Figure 2- 101 Table 2- 64 The Record menu (Page 1/2)







Menu	Settings	Comments
Mode	Record Play back Storage OFF	Select record mode Select play back mode Select storage mode Turn off all recorder functions
Source	CH1 CH2 P/F-OUT	Select record source channel
End Frame	 <1-1000>	Set number of record frames
Operate	 (Run)  (Stop)	Record stopped, press to Start recording Recording, press to stop

Figure 2- 102 Table 2- 65 The Record menu (Page 2/2)



Menu	Settings	Comments
Interval	 <1.00ms-1000s>	Set time interval

3. Play back: Play back the recorded waveforms.

Press **Utility** → **Record** → **Mode** → **Play back** to go to the following menu.

Figure 2- 103 Table 2- 66 The Record menu (Page 1/2)







Menu	Settings	Comments
Operate	 (Run)	Play stopped, press to Start playback
	 (Stop)	Playing, press to stop
Play mode		Set repeat play mode
		Set single time play mode
Interval	 <1.00ms-20s>	Set up interval

Figure 2- 104 Table 2- 67 The Record menu (Page 2/2)



Menu	Settings	Comments
Start Frame	<1-1000>	Set start frame
Current Frame	<1-1000>	Select current frame to be played
End Frame	<1-1000>	Set End frame

NOTE: The **RUN/STOP** button can also replay or continue the waveform display.

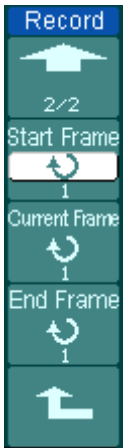
4. Storage: Store recorded waveforms to non-volatile memory according to setup frames.

Press **Utility** → **Record** → **Mode** → **Storage** to go to the following menu.

Figure 2- 105 Table 2- 68 The Storage menu (Page 1/2)

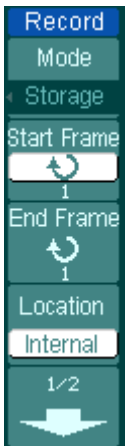

Menu	Settings	Comments
Start Frame	<1-1000>	Set first frame to be saved
End Frame	<1-1000>	Set last frame to be saved
Location	Internal external	Set up Store location

Figure 2- 106 Table 2- 69 The Storage menu (Page 1/2)



When the save to Internal memory

Menu	Settings	Comments
Save		Save recorded waveform to internal memory location
Load		Recall recorded waveform from internal memory location
Imp./Exp.		Go to import/export menu (same as REF import/export menu. See table 2-10)

Figure 2- 107 Table 2- 70 The Storage menu when the save as external memory



Menu	Settings	Comments
Save		Go to save menu (same as REF save menu. See table 2-12)
Load		Go to load menu see table 2-63
Import		Go to import menu. (same as REF import menu see table 2-14)

Print Setting

DS1000E, DS1000D series oscilloscopes support print function. Please execute print operation according to the following steps:

1. Connect printer:

DS1000E, DS1000D series oscilloscopes provide two print modes: "Normal" and "PictBridge".

- If use PictBridge printer, please select "PictBridge" mode, and then connect the oscilloscopes regarded as "Device equipment" and printer via USB Device port on the rear panel.

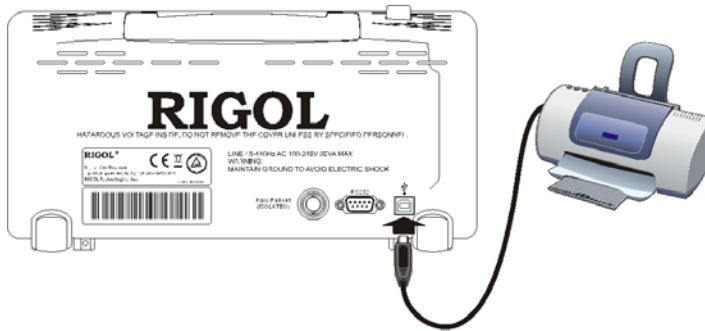

Figure 2- 108
PictBridge print

- If use Normal printer, please select "Normal" mode, and then connect the oscilloscopes regarded as "Host equipment" and printer via USB Host port on the front panel.

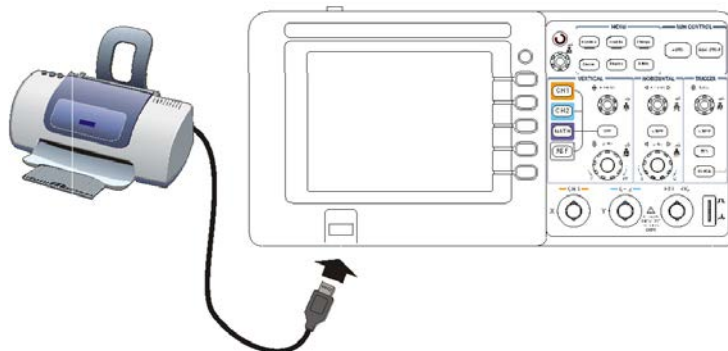

Figure 2- 109
Normal print

2. To set up print parameters:

Press **Utility** → **Print set** to enter the following menu.

Figure 2- 110 Table 2- 71 The Print Set Menu (“Normal” Mode)



Menu	Settings	Comments
Print Mode	Normal PictBridge	Select the print mode
Print		Execute print function
Inverted	ON OFF	Set up the invert of printing color on or not
Palette	Gray scale Color	Set up print color

Figure 2- 111 Table 2- 72 The Print Set Menu (“PictBridge” Mode, Page1/3)

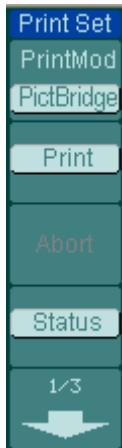

Menu	Settings	Comments
Print Mode	Normal PictBridge	Select the print mode
Print		Execute print function
Abort		Stop print function
Status		Query the status of print job

Figure 2- 112 Table 2- 73 The Print Set Menu (“PictBridge” Mode, Page2/3)

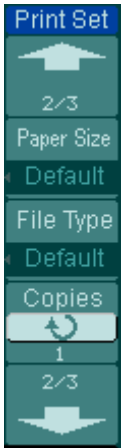

Menu	Settings	Comments
Paper Size	Default A4, A5 and so on	Select the print paper size: default, A2, A3, A4, A5, A6 and B5
File Type	Default Bmp Exif/Jpeg	Select the print image type
Copies	 <1-999>	Adjust the print copies

Figure 2- 113 Table 2- 74 The Print Set Menu (“PictBridge” Mode, Page3/3)



Menu	Settings	Comments
Print Quality	Default Normal Draft Fine	Select the print quality
Palette	Gray scale Color	Select the palette
Inverted	ON OFF	Turn the invert on or off

3. Print:

Make sure the Printer has been connected and the print settings are all ready before printing. Then, press **Utility** → **Print set** → **Print** to execute print operation.

Preference

Press **Utility** → **Preference** to go to the following menu

Figure 2- 114 Table 2- 75 The Preference menu (1/2)



Menu	Display	Comments
Screen saver	1 min . . 5 hour OFF	Set up screen saver timer
Expand Refer.	Ground Center	Set up waveform vertical expand reference
Sticky key	/	Set up sticky state of CH1, CH2, Math, Ref, Trig Level and Trig Position
Skin	Classical Modern Tradition Succinct	Set up skin style

Figure 2- 115 Table 2- 76 The Preference menu (2/2)



Menu	Display	Comments
Set Keys	/	Set up new code

Key Points:

1. **Screen saver:** This function extends the life of LCD backlighting system.
2. **Expand reference:** When changing the volts/div. for channels, the signal expands or compresses around the signal ground level, or the center of the screen. When **Center** is selected, the waveform will expand or compress around the center of the display. When **Ground** is selected, the channel ground level will remain the same position on the display and waveform will zoom about the ground level.
3. **Sticky key:** If sticky feature is turned ON, when adjusting positions (CH1, CH2, MATH, REF, Trig.Lev. and Trig.Pos.), the object will stop at zero position until next adjustment, for the ease of getting back to initial positions.
4. **Key Sets:** This function help users to set new code to unlock the keyboard.

Self-Calibration

The Self-Calibration adjusts the internal circuitry to get the best accuracy. Use these functions to calibrate the vertical and horizontal systems. For maximum accuracy at any time, run this calibration if the ambient temperature changes by 5°C or more.

Disconnect any probes or cables from all channel inputs, otherwise failure or damage to the oscilloscope may occur. Press **Utility** → **Self-Cal** to enter the self-calibration interface as follows. Press "RUN/STOP" key to start the operation and press "AUTO" key to exit the system.

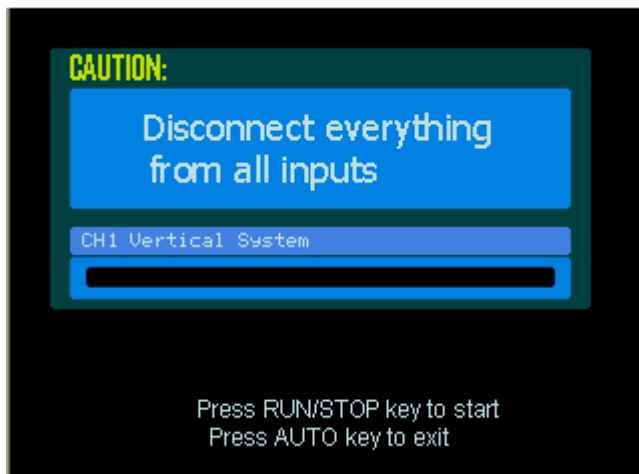



Figure 2- 116
Self calibration

NOTE: The oscilloscope must have been working or warm-up **at least 30-minutes** before running self-calibration to get best accuracy.

System Information

System information can help users to query the instrument model, serial number, software version, installed module and so on.

Press **Utility** → **System Info** to enter the system information interface as follows.



```
Model:          DS1102E

Serial No.     DS1EB104702974

Software version: 00.02.01 SP1

Installed module: FFT  Module installed
                  USB  Module installed
                  P/F  Module installed
                  RS232 Module installed

Press RUN/STOP key to exit
```

Figure 2- 117
System information interface

Special Mode

DS1000E, DS1000D series oscilloscopes provide a new function “Key Lock”, which can meet the needs of industrial production. In this mode, except from F1 to F5 and MENU ON/OFF, other keys are locked. You must input keys to unlock the keyboard, the initial password is “111111”, Further more, you can reset new keys with six-length by keys setting menu.

More details for operation steps please refer to the following introductions:

1. Lock the keyboard

Press **Utility** button, press **Special Mode** menu to enter the **Lock** mode; then choose **OK** to start keyboard locked function as the following figure. In this mode, except from F1 to F5 and MENU ON/OFF, other keys are locked. If you choose **cancel**, it will cancel this function.



Figure 2- 118
Interface of keyboard locked

2. Unlock the keyboard

Press any button among F1 to F5 to enter the **Unlock** mode, then please input the unlock keys (the default is 111111, users can reset new keys with 6 bit length.) to unlock the keyboard.



Figure 2- 119
Interface of keyboard unlock

3. Reset the keys

Press **Utility** button to choose the **Preference** menu, then choose **set keys** option in second page of the menu just like the following figure. Input the old keys and press **Enter**, input your new code and ensure it again, the system will clew that you have finished new keys setting.



Figure 2- 120
Interface of key resetting

To Measure Automatically

The **Measure** button in the menu area activates the automatic measurement function. The instruction below shows the powerful measurement function of the oscilloscopes.

Auto measurement setup button

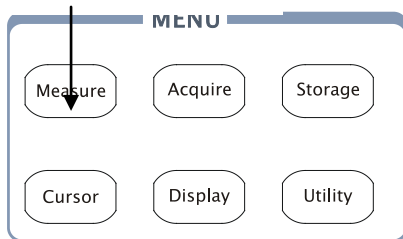

Figure 2- 121

Auto measurement setup button

Menu explanation:

Press the **Measure** button to display the menu for the settings of the Automatic Measurements.

The oscilloscopes provide 22 auto measurements: Vpp, Vmax, Vmin, Vtop, Vbase, Vamp, Vavg, Vrms, Overshoot, Preshoot, Freq, Period, Rise Time, Fall Time, Delay1 → 2 \overline{f} , Delay1 → 2 \overline{t} , Phas1 → 2 \overline{f} , Phas1 → 2 \overline{t} , +Width, -Width, +Duty, -Duty (10 voltage and 12 timing measurements).

Figure 2- 122 Table 2- 77 The Measure menu



Menu	Settings	Comments
Source	CH1 CH2	Select CH1 or CH2 as source channel for measurement
Voltage		Select to measure voltage parameter
Time		Select to measure time parameter
Clear		Clear measurement result on screen
Display All	OFF ON	Turn off all measurement results Turn on all measurement results

10 Voltage Measurement Parameters

Figure 2- 123 Table 2- 78 The Voltage Measurements menu (Page 1/3)



Menu	Settings	Comments
Vmax		Measure maximum voltage of a waveform
Vmin		Measure minimum voltage of a waveform
Vpp		Measure Peak-to-Peak Voltage
Vtop		Measure a flat top voltage of a square waveform

Figure 2- 124 Table 2- 79 The Voltage Measurements menu (Page 2/3)

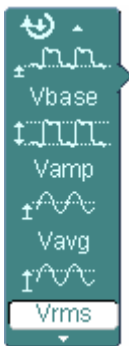

Menu	Settings	Comments
Vbase		Measure a flat base voltage of a square waveform
Vamp		Measure voltage between Vtop and Vbase
Vavg		Measure average voltage of a waveform
Vrms		Measure Root Mean Square Voltage of a waveform

Figure 2- 125 Table 2- 80 The Voltage Measurements menu (Page 3/3)



Menu	Settings	Comments
Overshoot		Measure overshoot in percentage of an edge
Preshoot		Measure preshoot in percentage of an edge

10 Time Measurement Parameters

Figure 2- 126 Table 2- 81 The Time Measurements menu (Page 1/4)



Menu	Settings	Comments
Period		Measure Period of a waveform
Freq		Measure Frequency of a waveform
Rise time		Measure Rise Time of a rising edge
Fall time		Measure Fall Time of a falling edge

Figure 2- 127 Table 2- 82 The Time Measurements menu (Page 2/4)

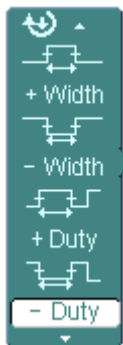

Menu	Settings	Comments
+Width		Measure +Pulse Width of a pulse wave
-Width		Measure -Pulse Width of a pulse wave
+Duty		Measure +Duty Cycle of a pulse wave
-Duty		Measure -Duty Cycle of a pulse wave

Figure 2- 128 Table 2- 83 The Time Measurements menu (Page 3/4)



Menu	Settings	Comments
Delay1→2 f		Measure the signals delay between two channels at the rising edge
Delay1→2 t		Measure the signals delay between two channels at the falling edge

Figure 2- 129 Table 2- 84 The Time Measurements menu (Page 4/4)

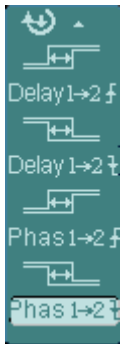

Menu	Settings	Comments
Phas1→2f		Measure the phase deviation between two channels at the rising edge
Phas1→2f		Measure the phase deviation between two channels at the falling edge

NOTE: The results of the automatic measurements will be displayed on the bottom of the screen. Maximum 3 results could be displayed at the same time. When there is no room, the next new measurement result will make the previous results moving left out of screen.

Using Automatic Measurement

1. Select the signal channel for measuring. CH1 or CH2 according to the signal of interest.

Press soft buttons as follows: Measure → Source → CH1 or CH2.

2. To see all measurement values, set the Display All to ON. 18 measurement parameters will be displayed on the screen (except for "Delay1→2 μ s" and "Delay1→2 τ ").

3. Select parameters page for measuring; select voltage or time parameters pages by pressing soft button as follows: Measure → Voltage or time → Vmax, Vmin.....

4. To get the measured value on the screen; select the parameters of interest by pressing the soft button on the right of the menu, and read the data on the bottom of the screen.

If the data is displayed as "*****", it means the parameter cannot be measured in current condition.

5. Clear the measure values: press Clear and all of the auto measure values would disappear from the screen (except for "Display all" parameters).

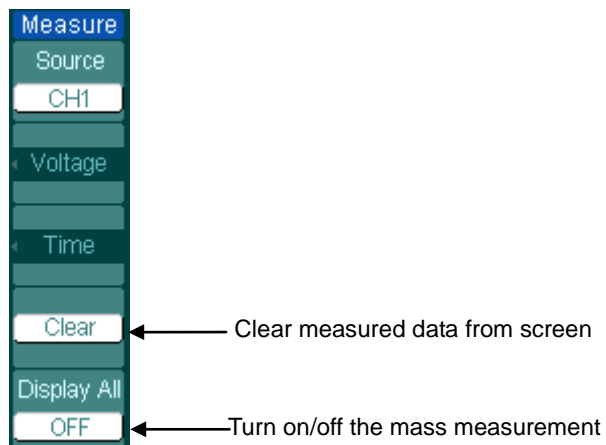

Figure 2- 130
Measurement display

The automatic measurement of voltage parameters

The oscilloscope provides automatic voltage measurements including V_{pp} , V_{max} , V_{min} , V_{avg} , V_{amp} , V_{rms} , V_{top} , V_{base} , **Overshoot** and **Preshoot**. Figure below shows a pulse with some of the voltage measurement points.

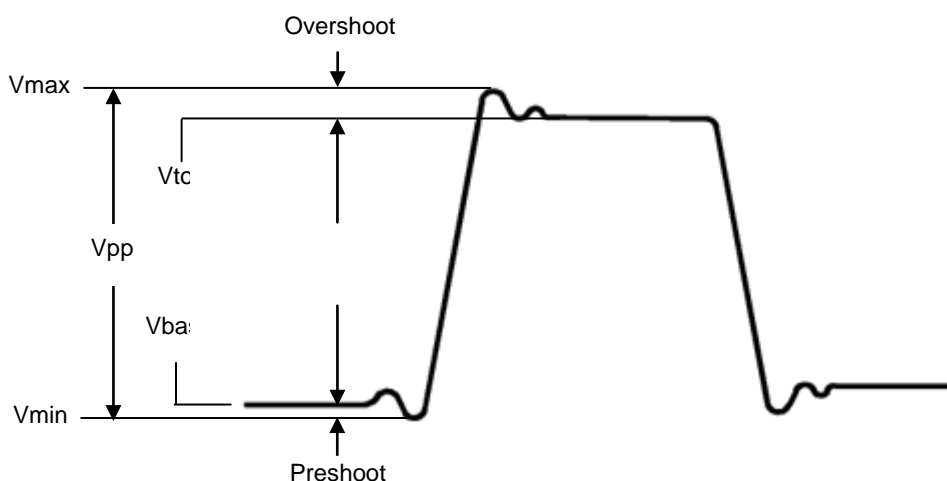

Figure 2- 131
Voltage parameters

Vpp: Peak-to-Peak Voltage.

Vmax: The maximum amplitude. The most positive peak voltage measured over the entire waveform.

Vmin: The minimum amplitude. The most negative peak voltage measured over the entire waveform.

Vamp: Voltage between V_{top} and V_{base} of a waveform

Vtop: Voltage of the waveform's flat top, useful for square/pulse waveforms.

Vbase: Voltage of the waveform's flat base, useful for square/pulse waveforms.

Overshoot: Defined as $(V_{max}-V_{top})/V_{amp}$, useful for square and pulse waveforms.

Preshoot: Defined as $(V_{min}-V_{base})/V_{amp}$, useful for square and pulse waveforms.

Average: The arithmetic mean over the entire waveform.

Vrms: The true Root Mean Square voltage over the entire waveform.

The automatic measurement of time parameters

The oscilloscope provides time parameters auto-measurements include Frequency, Period, Rise Time, Fall Time, +Width, -Width, Delay 1→2 f , Delay 1→2 t , Phas 1→2 f , Phas 1→2 t , +Duty and -Duty. The following figure shows a pulse with some of the time measurement points.

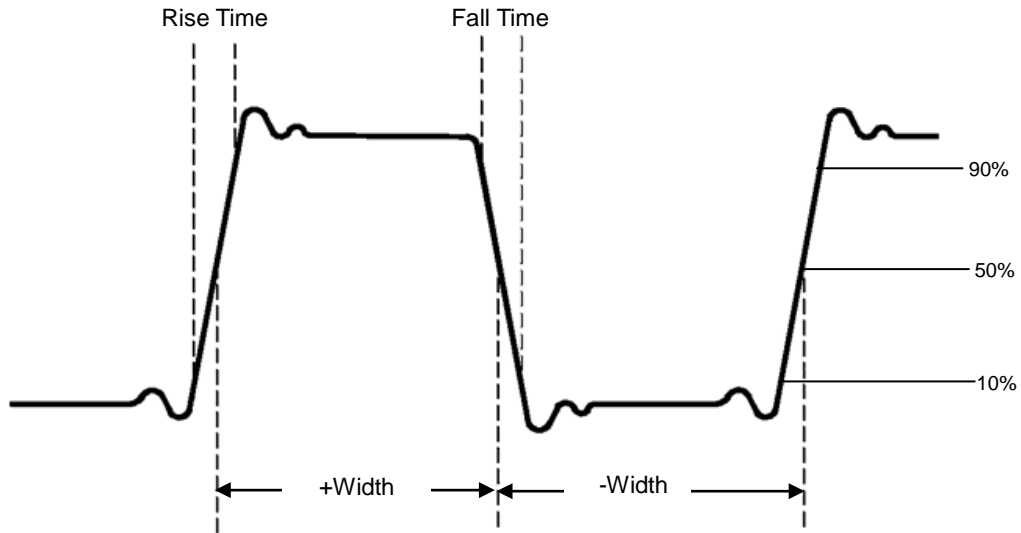

Figure 2- 132 Time parameters

Rise Time: Time that the leading edge of the first pulse in the waveform takes to rise from 10% to 90% of its amplitude.

Fall Time: Time that the falling edge of the first pulse in the waveform takes to fall from 90% to 10% of its amplitude.

+Width: The width of the first positive pulse in 50% amplitude points.

-Width: The width of the first negative pulse in the 50% amplitude points.

Delay 1→2 f : The delay between the two channels at the rising edge.

Delay 1→2 t : The delay between the two channels at the falling edge.

Phas 1→2 f : The phase deviation between the two channels at the rising edge.

Phas 1→2 t : The phase deviation between the two channels at the falling edge.

+Duty: +Duty Cycle, defined as +Width/Period

-Duty: -Duty Cycle, defined as -Width/Period

To Measure with Cursors

Figure displays the **Cursor** button on the front-panel.

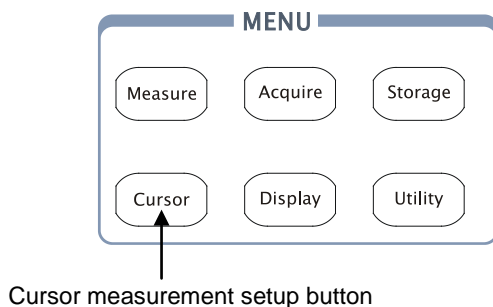

Figure 2- 133

Cursor measurement setup button

The cursor measurement has three modes: Manual, Track and Auto Measure.

1. Manual Mode:

In this mode, the screen displays two parallel cursors. Move the cursors to make custom voltage or time measurements of the signal. The values are displayed on the boxes below the menu. Before using cursors, make sure to set the Signal Source as the channel for measuring.

2. Track Mode:

In this mode, the screen displays two cross cursors. The cross cursor sets the position on the waveform automatically. Adjust cursor's horizontal position on the waveform by rotating the multifunctional knob (🔄). The oscilloscope displays the values of the coordinates on the boxes below the menu.

3. Auto Mode:

This mode will take effect with Automatic Measurements. The instruments will display cursors while measuring parameters automatically. These cursors demonstrate the electrical meanings of these measurements.

NOTE: The Auto Measure mode for Cursor measuring will take no effect without automatic measurements.

Manual Mode

Press **Cursor** → **Mode** → **Manual** to display the manual mode menu.

Figure 2- 134 Table 2- 85 The Manual Mode Menu



Menu	Settings	Comments
Mode	Manual	Adjust the cursor to measure X/Y parameters manually
Type	X	Shown as vertical line to measure the horizontal parameters
	Y	Shown as horizontal line to measure the vertical parameters
Source	CH1 CH2 MATH LA	Select the measurement signal source. (LA is only for DS1000D series)

In this mode, the oscilloscope measures the Y or X coordinate values of the cursors, and the increments between the two cursors.

When the cursor is in X type, a pair of vertical cursors CurA and CurB will be appeared in the screen, whose time value could be measured separately as well as the time difference between them, and which will be changed with the location of cursor if you twirl the knob.

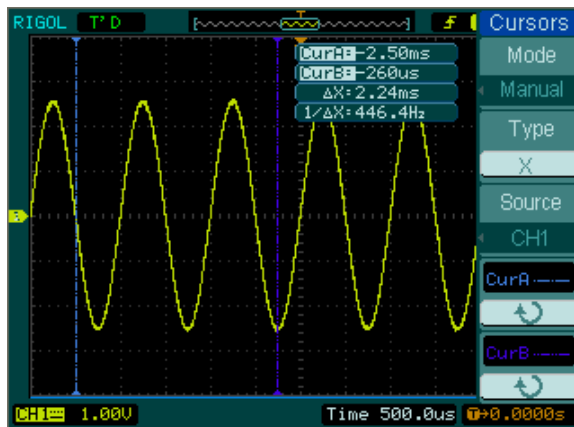



Figure 2- 135
Manual Measure Mode of Cursor Measurement

When the cursor is in Y type, a pair of horizontal cursors CurA and CurB will be appeared in the screen, whose voltage value could be measured separately as well as the voltage difference between them, and which will be changed with the location of cursor if you twirl the knob .

To do manual Cursor Measurements, please do as the following steps:

1. Select the **Manual** mode for cursor measurement by pressing soft button as:

Cursor → **Mode** → **Manual**.

2. Select channel **Source** for measurements by pressing soft button as:





Cursor → **Source** → **CH1**, **CH2**, **MATH (FFT)** or **LA** (DS1000D series)

NOTE: While measuring the channel of MATH, the results are valued with “d” (division) as units.

3. Select the cursors type by pressing soft button as **Cursor** → **Type** → **X** or **Y**.

4. Move the cursors to adjust the increment between the cursors: (Details in the following Table)

Table 2- 86 The Cursor menu

Cursor	Increment	Operation
Cursor A	X	Turn the multifunctional knob  to move cursor A horizontally
	Y	Turn the multifunctional knob  to move cursor A vertically
Cursor B	X	Turn the multifunctional knob  to move cursor B horizontally
	Y	Turn the multifunctional knob  to move cursor B vertically

NOTE: Cursor could be moved only when the curse function menu is displayed.

5. To get measurement values:

Position of Cursor A (time cursor centered on the midpoint of screen; Voltage cursor centered on channel ground level).

Position of Cursor B (same as above).

Horizontal space between cursor A and B (ΔX): Time between cursors ($1/\Delta X$), units in Hz, kHz, MHz, GHz.

Vertical space between cursor A and B (ΔY): Voltage between cursors

If you choose the source as LA (DS1000D series), the measurement value is as follows:

Position of Cursor A (time cursor centered on the midpoint of screen).

Position of Cursor B (time cursor centered on the midpoint of screen).

Cursor A value: Hex.

Cursor A value: Binary.

Cursor B value: Hex.

Cursor B value: Binary.

NOTE: The values will be automatically displayed on the right upper corner of screen when the cursor function menu is hidden or displaying other menus.

Key Points

Cursor Y: Cursors Y appear as horizontal lines on the display to measure vertical parameters. Usually it is used to measure the Volts. When the source is set as function, the units are assigned to the function.

Cursor X: Cursor X appears as vertical lines on the display to measure horizontal parameters. Usually it indicates the time of trigger excursion. When the source is set as FFT, X means frequency.

Track Mode

Press **Cursor** → **Mode** → **Track** to display the track mode menu.

Figure 2- 136 Table 2- 87 The Track Mode Menu

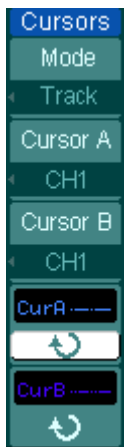

Menu	Settings	Comments
Mode	Track	Set Track mode in cursor measurement
Cursor A	CH1 CH2 None	Set Cursor A in conjunction with CH1, CH2 or turn off Cursor A
Cursor B	CH1 CH2 None	Set Cursor B in conjunction with CH1, CH2 or turn off Cursor B
CurA (Cursor A)	↻	Turn the multifunctional knob (↻) to move cursor A horizontally
CurB (Cursor B)	↻	Turn the multifunctional knob (↻) to move cursor B horizontally

In Track mode, the cross cursor is displayed on the waveform under measuring. If you move the horizontal position of cursor, the horizontal coordinate and vertical coordinate of current point as well as the increments of them will be displayed immediately. Note: horizontal coordinate represents time value, vertical coordinate represents voltage value.

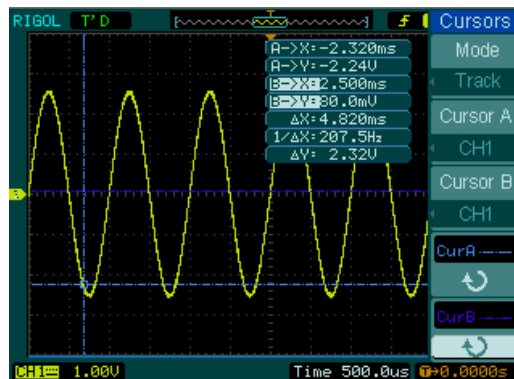

Figure 2- 137

Track Measure Mode of Cursor Measurement

To do Track mode Cursor Measurements, follow these steps:

1. Select the Track mode for cursor measurement by pressing soft button as:
Cursor → Mode → Track.
2. Select channel Source for Cursor A and Cursor B by pressing soft button as:
Cursor → Cursor A or Cursor B → CH1, CH2 or None.
3. Move the cursors to adjust the horizontal positions of the cursors: (Details in the following Table)

Table 2- 88 The Cursor usage

Cursor	Operation
Cursor A	Turn the multifunctional knob (↻) to move cursor A horizontally
Cursor B	Turn the multifunctional knob (↻) to move Cursor B horizontally

NOTE: Moving cursor horizontally is not allowed when other (not tracking cursor) menu is activated

4. To get measurement value:

Position of Cursor 1 (Time cursor centered on the midpoint of screen; Voltage cursor centered on channel ground level).

Position of Cursor 2 (Time cursor centered on the midpoint of screen; Voltage cursor centered on channel ground level).

Read the horizontal space between Cursor 1 and 2 (ΔX): Time between cursors, units in seconds.

$(1/\Delta X)$, units in Hz, kHz, MHz, GHz.

Vertical space between cursor 1 and 2 (ΔY): Voltage between cursors, units in V.

Auto Mode

Press **Cursor** → **Mode** → **Auto** to display the auto mode menu.

Figure 2- 138 Table 2- 89 The Auto Mode Menu



Menu	Settings	Comments
Mode	Auto	Display the cursors for the current automatic measuring. (See the following figure)

There will be no cursor display if no parameters are chosen in Measure menu. The oscilloscope could move cursor automatically to measure 22 parameters in **Measure** menu.

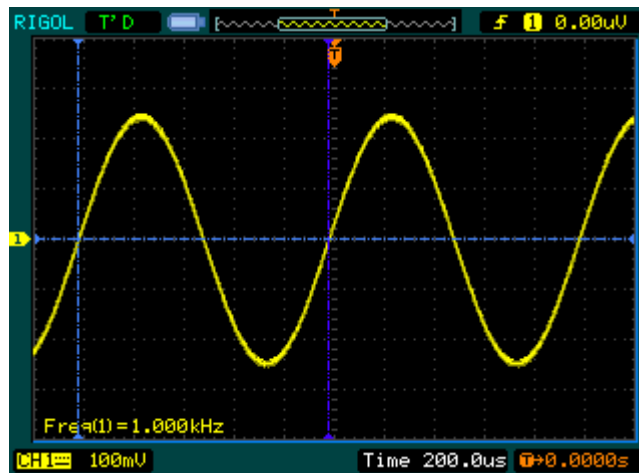

Figure 2- 139
Auto Measure Mode of Cursor Measurement

To Use Run Control Buttons

The run control buttons include **AUTO** (auto setting) and **RUN/STOP**.

Auto:

The **AUTO** features automatic adjustments to produce a usable display of the input signal. Press **AUTO** button, the following menu appears.

Figure 2- 140 Table 2- 90 The Auto menu



Menu	Settings	Comments
 Multi-Cycle		Press to display multi-cycle waveform on the screen
 Single Cycle		Press to display single cycle waveform on the screen
 Rise Edge		Press to display the waveform's rising edge and measure its rise time automatically
 Fall Edge		Press to display the waveform's falling edge and measure its fall time automatically
 (Cancel)		Press to cancel all the Auto Set actions, the oscilloscope will recover to its previous status

Auto-set functions

After the **AUTO** is pressed the oscilloscope is configured to the following defaults:

Table 2- 91 The Auto menu

Menu	Settings
Display format	Y-T
Acquire mode	Normal
Vertical coupling	Adjust to AC or DC according to the signal.
Vertical position	Adjust to right position
Vertical "V/div"	Adjust to right scale
Volts/Div	Coarse
Bandwidth limit	Full
Signal Invert	OFF
Horizontal position	Center
Horizontal "S/div"	Adjust to right scale
Trigger type	Edge
Trigger source	Find the channel with input signal automatically.
Trigger coupling	DC
Trigger voltage	Midpoint setting
Trigger mode	Auto

RUN/STOP: Run or Stop waveform acquiring.

NOTE: The volts/div and horizontal time base can be adjusted in a fixed limit. That is, to zoom in/out the signal in vertical and horizontal directions.

Chapter 3 Application & Examples

Example 1: Taking Simple Measurements

The function is used to observe an unknown signal; to display, measure frequency, and peak-to-peak amplitude.

To quickly display a signal, please do the steps as follow:

1. Set the probe and the channel attenuations to 10X
2. Connect signal to CH1 with the probe
3. Press the **AUTO** button

The oscilloscope sets the vertical, horizontal, and trigger controls at the best status automatically. To optimize the waveform display, adjust these controls manually to meet the requirements.

Selecting Automatic Measurements

The oscilloscope takes automatic measurements on most signals. To measure the frequency and the peak-to-peak amplitude, do these steps as follows:

1. Measure peak-to-peak amplitude

Press **Measure** → **Source** → **CH1** to set measurement source

Press **Voltage** → **Vpp** to select peak-to-peak measurements and the result will be displayed on the screen.

2. Measure frequency

Press **Measure** → **Source** → **CH1** to set measurement source

Press **Time** → **Freq** to select frequency measurements and the result will be displayed on the screen.

NOTE: The frequency and peak-to-peak measurements are shown on the screen and are updated periodically.

Example 2: View a Signal Delay Caused by a Circuit

This example is to test the input and output signals of a circuit and observe the signal delay. First, set the probe and the channel attenuation to 10X and connect CH1 probe to the input, CH2 to the output of the circuit.

Do these steps as follow:

1. Display the signals (CH1 and CH2):
 - (1) Press the **AUTO** button
 - (2) Adjust the vertical and the horizontal scale by turning the **SCALE** knobs to appropriate ranges for display.
 - (3) Press the **CH1** button to select Channel 1, and turn the vertical **POSITION** knob to adjust the vertical position of Channel 1 waveform.
 - (4) Press the **CH2** button to select Channel 2, and turn the vertical **POSITION** knob to adjust the vertical position of Channel 2 waveform.
2. Measure the delay time when a signal going through the circuit.

Auto-measuring the delay:

 - (1) Press **Measure** → **Source** → **CH1** to set measurement source.
 - (2) Press **Time** to select the measurement Type.
 - (3) Press **Delay 1** → **2f** to display the result on the screen.

You can see the change of the waveform in the following figure:

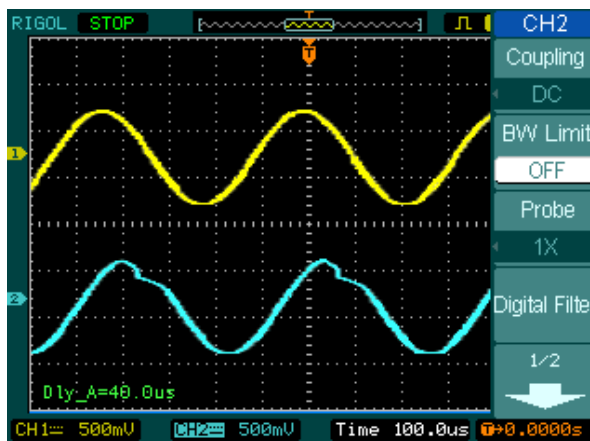

Figure 3- 1
Waveform distortion

Example 3: Capture a Single-Shot Signal

To capture a single event, it needs to gather some pre-test knowledge of the signal in order to set up the trigger level and slope correctly. For example, if the event is derived from TTL logic, a trigger level of 2 volts should work on a rising edge.

The following steps show how to use the oscilloscope to capture a single event.

1. Set the probe and the channel attenuations to 10X.
2. Set up the trigger.
 - (1) Press the **MENU** button in the Trigger control area to display the menu.
 - (2) Press **Edge** to select the trigger mode
 - (3) Press **Slope** to select **F**
 - (4) Press **Source** to select **CH1**
 - (5) Press **Sweep** to select **Single**
 - (6) Press **Set Up** → **Coupling** to select **DC**
3. Turn the vertical and horizontal **SCALE** knobs to adjust the Volts/Div and the Time base in a proper range for the signal
4. Turn the **LEVEL** knob to adjust trigger level
5. Press **RUN/STOP** button to start capturing. When the trigger conditions are met, data appears on the display representing the data points that the oscilloscope obtained with one acquisition.

This function helps to capture the occurrence easily, such as the noisy with large amplitude; set the trigger level higher a little above the normal level and press **RUN/STOP** and wait. When noise occurs, the instrument will record the waveform before and after the trigger. Adjust the **POSITION** button in the horizontal control area and change the level of the trigger position, will get the inverted delay trigger. It is useful to observe the waveform before the occurrence of the noise.

Example 4: To Reduce the Random Noise on a Signal

If the signal is noisy (Figure 3- 2), set up the oscilloscope to reduce the noise on the waveform and avoid its interference to the signal.

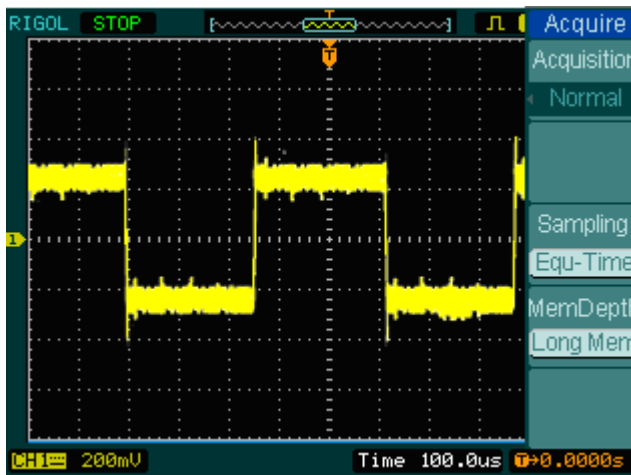

Figure 3- 2
Signal with noise

1. Set the probe and the channel attenuations to 10X.
2. Connect a signal to the oscilloscope and obtain a stable display.
3. Improve the trigger by setting the Coupling.
 - (1) Press the **MENU** in the Trigger control area.
 - (2) Press **Set Up**→**Coupling**→**LF Reject** or **HF Reject**

HF Reject (High frequency reject) adds a low pass filter with the -3 dB cut-off point at 150 kHz. Use HF rejects to remove high frequency noise such as AM or FM broadcast stations from the trigger path.

LF Reject (Low frequency reject) adds a high pass filter with the -3 dB cut-off point at 8 kHz. Use LF Reject to remove low frequency signals such as power line noise from the trigger path.

4. To reduce the noise by setting the acquisition type and adjust the waveform intensity.

- (1) If there is noise within the signal and the waveform looks too wide, in this case, choose average acquisition. In this mode the waveform will be thin and easy to observe and measure.

To use average follow these steps.

- Press soft button as **Acquire** → **Acquisition** → **Average**
- Toggle the **Averages** soft button to select the number of averages that best eliminates the noise from the displayed waveform. It can be adjusted from 2-256. (See Figure 3-3)

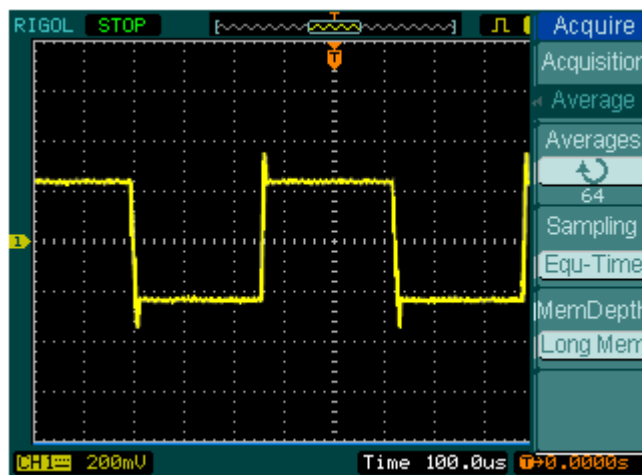

Figure 3- 3
Signal without noises

- (2) To reduce the noise it can also be achieved by reducing the intensity of the display.

NOTE: It is normal that the refresh rate will slow down when the average acquisition mode is ON.

Example 5: Making Cursor Measurements

There are 22 build-in automatic measurements. They can also be conducted using cursors to make time and voltage measurements of a waveform quickly.

Measure the Peak Frequency of the First Sinc Waveform

To measure the ringing frequency at the rising edge of a signal, do these steps:

1. Press **Cursor** key to see the Cursor menu.
2. Press **Mode** to set **Manual** mode.
3. Press **Type** to select **X**.
4. Turn (↻) knob to place cursor A on the first peak of the wave.
5. Turn (↻) knob to place cursor B on the second peak of the wave.

Observe the delta in time and frequency displayed on the screen.

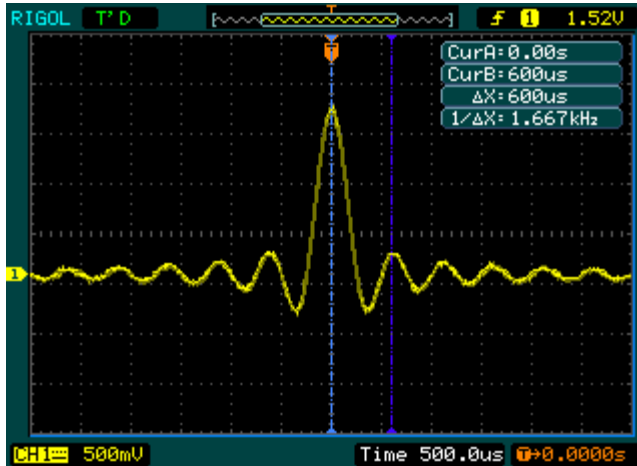

Figure 3- 4
Waveform display

Measure the Amplitude of the First Waveform Peak of the Sinc.

Please follow these steps:

1. Press **Cursor** key to see the Cursor menu.
2. Press **Mode** to set **Manual** mode
3. Press **Type** to select **V**.
4. Turn (↺) knob to place cursor A on the first peak of the wave.
5. Turn (↻) knob to place cursor B on the second peak of the wave.

Observe the following measurements in the cursor menu: (See Figure 3-5)

- The delta voltage (peak-to-peak voltage of the waveform)
- The voltage at Cursor 1
- The voltage at Cursor 2

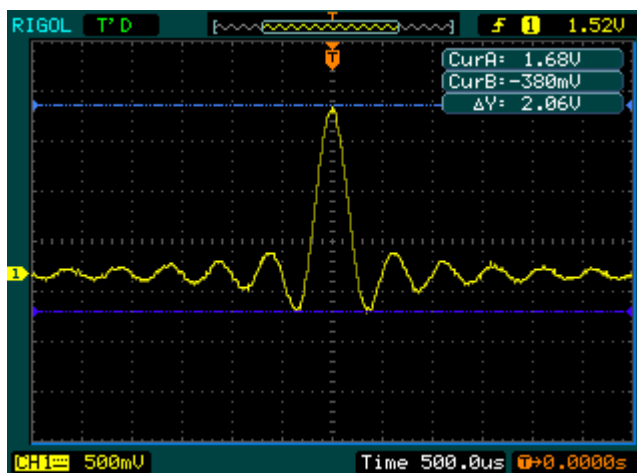

Figure 3- 5
Waveform display

Example 6: The application of the X-Y operation

Viewing Phase Changes through a Network

Theme: Connect the oscilloscope to monitor the input and output of the circuit and capture the phase changes.

To view the input and output of the circuit in an X-Y display, do these steps:

1. From the probe menu set the attenuation to 10X. Set the switch to 10X on the probes.
2. Connect the CH 1 probe to the input of the network, and connect the CH 2 probe to the output.
3. If the channels are not displayed, press the **CH1** and **CH2** buttons.
4. Press the **AUTO** button
5. Adjust the vertical **SCALE** knob to display approximately the same amplitude signals on each channel
6. Press the **MENU** in horizontal control area to display the menu
7. Press the **Time Base** soft button to select **X-Y**

The oscilloscope displays a Lissajous pattern representing the input and output characteristics of the circuit

8. Adjust the vertical **SCALE** and **POSITION** knobs to a desirable waveform display.
9. Apply the Ellipse method to observe the phase difference between the two channels.

(See Figure 3-6)

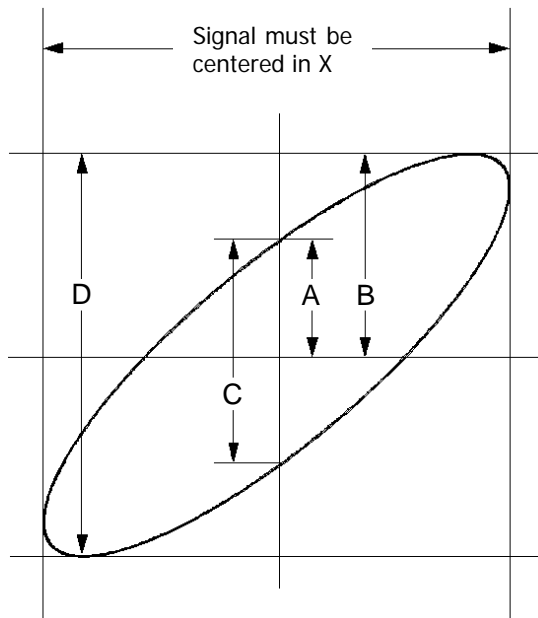

Figure 3- 6
Ellipse method to observe the phase difference

$\text{Sin}\theta = A/B$ or C/D , where θ = phase shift (in degrees) between the two signals.
From the formula above, you could get:

$$\theta = \pm \arcsine (A/B) \text{ or } \pm \arcsine (C/D)$$

If the main axis of the ellipse is at I and III quadrant, θ must be in the range of $(0 \sim \pi/2)$ or $(3\pi/2 \sim 2\pi)$. If the main axis is at II and IV quadrant, θ must be in the range of $(\pi/2 \sim \pi)$ or $(\pi \sim 3\pi/2)$.

Example 7: Triggering on a Video Signal

Test a video circuit in the DVD set. Use video trigger to obtain a stable display.

Triggering on Video Fields

To trigger on the video fields, please do as the following steps:

1. Press the **MENU** key in the Trigger control area to see the Trigger menu.
2. Press **Mode** to select **Video** mode.
3. Press **Source** to select **CH1** as trigger source.
4. Press **Polarity** to select **U**.
5. Press **Sync** as **Odd Field** or **Even Field**.
6. Adjust the **LEVEL** to set trigger level at the video sync pulse to get stable trigger.
7. Turn the horizontal **SCALE** knob to see a complete waveform on the screen.

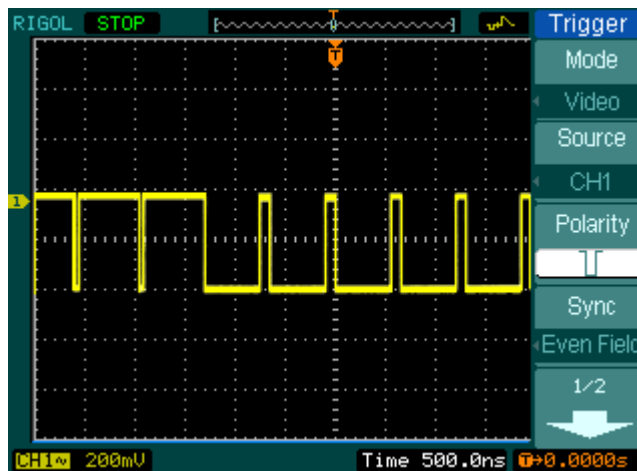

Figure 3- 7 Waveform display

The oscilloscope triggers on the Odd field or Even field. To avoid confusion when Odd field and Even field trigger simultaneously, choose Odd field or Even field as in step 5 above.

Triggering on the Video Lines

1. Press the **MENU** key in the Trigger control area to see the trigger menu.
2. Press **Mode** to select **Video**.
3. Press **Source** to select **CH1** as trigger source.
4. Press **Polarity** to select **U**.
5. Press **Sync** to select **Line Num**.
6. Turn (⌚) knob to trigger on a specified line number.
7. Adjust the **LEVEL** to set trigger level at the video sync pulse to get a stable trigger.
8. Turn the horizontal **SCALE** knob to observe a complete waveform on the screen.

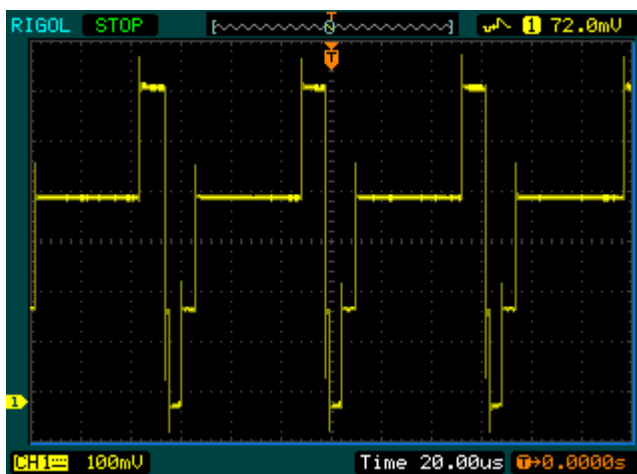

Figure 3- 8
Waveform display

Example 8: FFT Cursor measurement

FFT measurements include: Amplitude measurement (Vrms or dBVrms) and Frequency measurement (Hz).

Do these steps as follow:

1. Press **Cursor** → **Manual**.
2. Press **Type** to select X or Y.
3. Press **Source** to select FFT.
4. Turn (↻) knob to move the cursor to an interesting point.

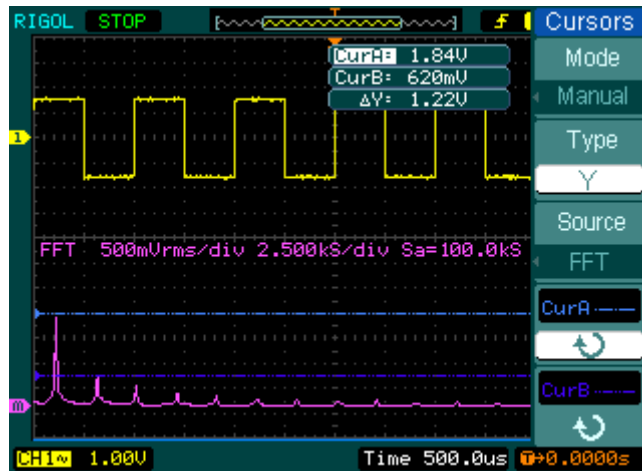

Figure 3- 9 The example of Cursor measuring FFT amplitude

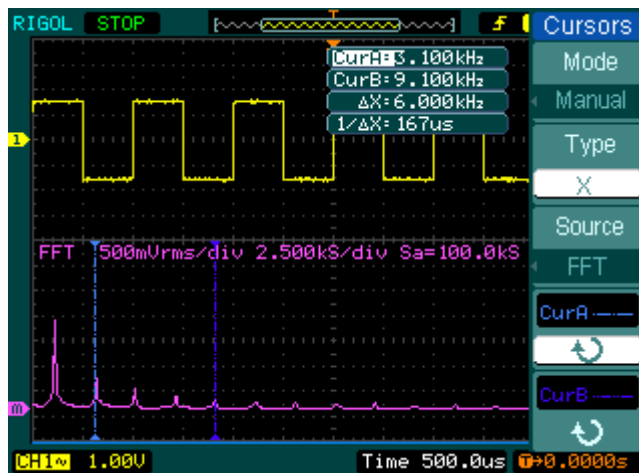

Figure 3- 10 The example of Cursor measuring FFT frequency

Example 9: Pass/Fail Test

When running test function the oscilloscope automatically examines the input signal, compared to the already built waveform mask. If the waveform “touches” the mask, a “Fail” occurs, otherwise the test passes. When needed, a programmable output can be used for external automatic control applications, such as the automatic failure product kick-out in a production line. The output is built in as a standard feature, and is optically isolated.

Do the steps as following:

1. Press **Utility** → **Pass/Fail**.
2. Press **Enable Test** and select **ON**.
3. Press **Mask Setting** → **Load**.
4. Press **Load** to recall the saved mask or press **X Mask** and **Y Mask** to adjust the horizontal limit and vertical limit then press **Create Mask** to create a new mask.
5. Press **Output** to select the expected outputting waveforms.
6. Press **Operate** to start the test.

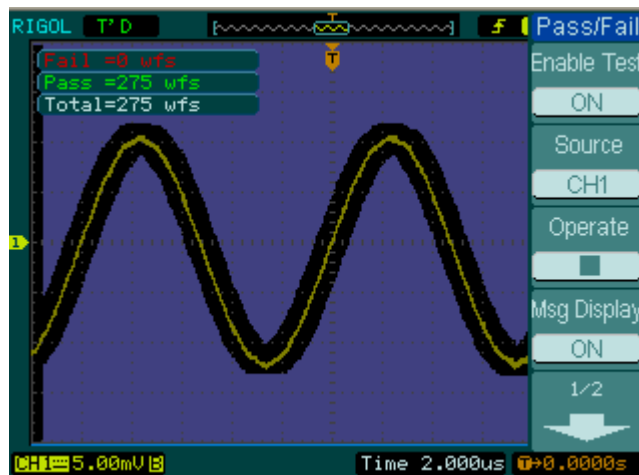

Figure 3- 11
Waveform display

Example 10: Triggering on a Digital Signal

The triggering way, especially to the **Digital Signal**, which the Pattern and Duration triggering are use for to carry on when triggering system was being used.

The two triggering ways are only allowed to a digital signal.

Pattern

Do the steps as following:

1. Press the **MENU** key in the triggering control area to see the trigger menu
2. Press **Mode** to select **Pattern** mode
3. Turn (↻)knob to select the channel you want to set
4. Press **Code** to set Code Setting (H, L, X, \uparrow , or \downarrow)
5. Press **Sweep** to select trigger mode to: Auto, Normal, or Single
6. Press **Set Up** to adjust the Holdoff time.

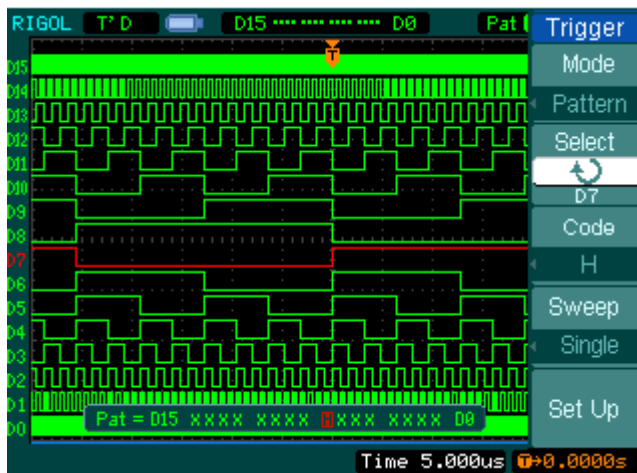

Figure 3- 12
Pattern Trigger on a digital signal

Duration

Do the steps as following:

1. Press the **MENU** key in the triggering control area to see the trigger menu
2. Press **Mode** to select **Duration** mode
3. Turn (↻) knob to select the channel you want to set
4. Press **Code** to set Code Setting (H, L, or X)
5. Press **Qualifier** to set time limit terms
6. Press **Time** to set duration and limit symbol time
7. Press **Sweep** to select trigger mode to: Auto, Normal, or Single
8. Press **Set Up** to adjust the Holdoff time.

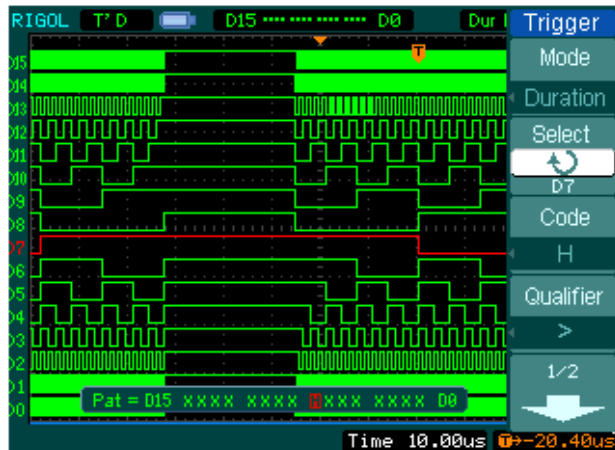

Figure 3- 13 Duration Trigger on a digital signal

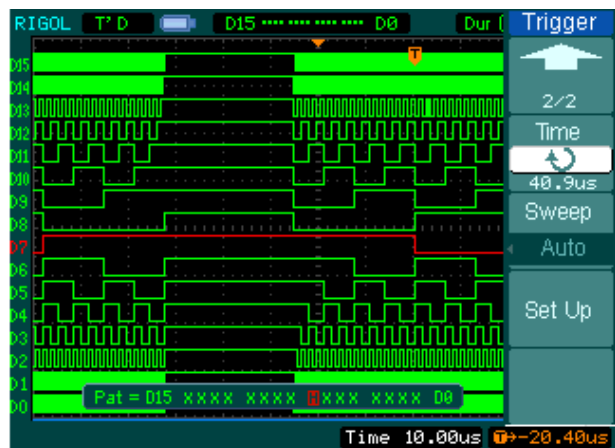

Figure 3- 14 Duration Trigger on a digital signal

Chapter 4 Troubleshooting

1. After the oscilloscope is powered on, the screen remains dark (no display):

- (1) Check the power cable connection.
- (2) Check if the power switch is turned on.
- (3) After the above inspection, restart the oscilloscope.
- (4) If the problem still remains, please contact **RIGOL** for help.

2. After the signal acquisition the waveform does not appear:

- (1) Check if the probes are correctly connected with the signals.
- (2) Check if the probes are firmly connected to the channels.
- (3) Check if the probes are correctly connected with the object being tested.
- (4) Check if the circuit can generate signal at the test point (Connect the probe compensator output to an input channel to confirm whether the testing point has no signal or the input channel is in some troubles).
- (5) Repeat the acquisition.

3. The measurement result is 10 times higher or lower than the value expected.



Check if the probe attenuation is the same as the channel attenuation.

4. If the oscilloscope does not get a stable waveform display:

- (1) Check the **Trigger Source** and notice if it is set to the channel in use.
- (2) Check the **Trigger Type**. Use "Edge" for normal signals, and use "Video" for VIDEO signals.
- (3) Switch the **coupling** into **HF Rejection** or **LF Rejection** in order to filter the noise which disturbs trigger.
- (4) Adjust the trigger **Sensitivity** and the **hold off** time.

5. After pressing the **RUN/STOP** button, the oscilloscope does not display any waveform on screen.

Check whether the **Trigger Mode** is set to "Normal" or "Single" and see whether the trigger level is out of the signal range. If yes, set the trigger level in

proper range by turning the  **LEVEL** knob or pressing the  button. Or set the Trigger Mode as "AUTO". Moreover, push  button to display the waveform on screen.

6. After the Acquisition is set to "Averages" or Display Persistence is set ON, the waveform refreshes slowly.

It is normal in these settings.

7. The signal is displayed as ladder like waveform.

- (1) The time base setting maybe is too low. Turn the horizontal  **SCALE** knob to increase horizontal resolution to improve the display.
- (2) Maybe the display **Type** is set to "Vectors" set it to "Dots" mode to improve the display.

Chapter 5 Specifications

All specifications apply to DS1000E, DS1000D Series Oscilloscopes unless where noted. To come up to these specifications, two conditions must be met firstly:

- The instrument must have been operated continuously for 30 minutes under the specified operating temperature.
- Do perform Self Calibration operation through the **Utility** menu, if the range of operating temperature variations up to or more than 5°C.

NOTE: All specifications are guaranteed unless where marked "typical".

Specifications

Acquisition			
Sample Modes	Real-Time Sample	Equivalent Sample	
Sample Rate	1GSa/s ^[1] , 500MSa/s	DS1102X	DS1052X
		25GSa/s	10GSa/s
Averages	The waveform will be displayed one time while all the channels finish N times Sample, N could be selectable from 2, 4, 8, 16, 32, 64, 128 and 256		

Inputs	
Input Coupling	DC, AC, GND
Input Impedance	1M Ω ±2% The input capacity is 18pF±3pF
Probe Attenuation Factors	1X, 5X, 10X, 50X, 100X, 500X, 1000X
Maximum Input Voltage	400V (DC+AC Peak, 1M Ω input impedance)
	40V (DC+AC Peak) ^[2]
Time Delay between Channel (typical)	500ps

Horizontal				
Sample Rate Range	Real-Time: 13.65Sa/s-1GSa/s Equivalent: 13.65Sa/s-25GSa/s			
Waveform Interpolation	Sin(x)/x			
Memory depth	Channel Mode	Sample rate	Memory Depth (normal)	Memory Depth (long record)
	Single channel	1GSa/s	16kpts	N.A.
	Single channel	500MSa/s or lower	16kpts	1Mpts
	Dual channel	500MSa/s or lower	8kpts	N.A.
	Dual channel	250MSa/s or lower	8kpts	512kpts
Scanning Speed	2ns/div~50s/div, DS1102X			

Range (Sec/div)	5ns/div~50s/div, DS1052X 1-2-5 Sequence
Sample Rate and Delay Time Accuracy	±50ppm (any interval ≥1ms)

Vertical	
A/D converter	8-bit resolution, all channels samples simultaneously
Volts/div Range	2mV/div~10V/div at input BNC
Maximum Input	Maximum input voltage on analog channel CAT I 300Vrms, 1000Vpk; instantaneous overvoltage 1000Vpk CAT II 100Vrms, 1000Vpk RP2200 10:1: CAT II 300Vrms RP3300A 10:1: CAT II 300Vrms
Offset Range	±40V (250mV/div~10V/div) ±2V (2mV/div~245mV/div)
Analog Bandwidth	100MHz (DS1102D, DS1102E) 50MHz (DS1052D, DS1052E)
Single-shot Bandwidth	100MHz (DS1102D, DS1102E) 50MHz (DS1052D, DS1052E)
Selectable Analog Bandwidth Limit (typical)	20MHz
Lower Frequency Response (AC -3dB)	≤5Hz (at input BNC)
Rise Time at BNC, (typical)	<3.5ns, <7ns, (respectively at 100MHz, 50MHz)
Dynamic range	±5div
DC Gain Accuracy	2mV/div-5mV/div: ±4% (Normal or Average acquisition mode) 10mV/div-10V/div: ±3% (Normal or Average acquisition mode)
DC Measurement Accuracy, Average	Average of ≥16 Waveforms with vertical position at zero: ±(DC Gain Accuracy×reading+0.1div+1mV)

RIGOL

Acquisition Mode	Average of ≥ 16 Waveforms with vertical position not at zero: $\pm[\text{DC Gain Accuracy} \times (\text{reading} + \text{vertical position}) + (1\% \text{ of vertical position}) + 0.2\text{div}]$ Add 2mV for settings from 2mV/div to 245 mV/div Add 50mV for settings from 250mV/div to 10V/div
Delta Volts Measurement Accuracy (Average Acquisition Mode)	Delta Volts between any two averages of 16 waveforms acquired under same setup and ambient conditions: $\pm(\text{DC Gain Accuracy} \times \text{reading} + 0.05 \text{ div})$

Trigger		
Trigger Sensitivity	0.1div~1.0div (adjustable)	
Trigger Level Range	Internal	± 6 divisions from center of screen
	EXT	$\pm 1.2\text{V}$
Trigger Level Accuracy (typical) applicable for the signal of rising and falling time $\geq 20\text{ns}$	Internal	$\pm(0.3\text{div} \times \text{V/div})(\pm 4 \text{ divisions from center of screen})$
	EXT	$\pm(6\% \text{ of setting} + 200 \text{ mV})$
Trigger Offset	Normal mode: pre-trigger (memory depth/ 2*sample rate), delayed trigger 1s	
	Slow Scan mode: pre-trigger 6div, delayed trigger 6div	
Trigger Holdoff Range	500ns~1.5s	
Set Level to 50% (Typical)	When input signal frequency $\geq 50\text{Hz}$	
Edge Trigger		
Edge Trigger Slope	Rising, Falling, Rising + Falling	
Pulse Width Trigger		
Trigger Condition	$(>, <, =)$ positive pulse width, $(>, <, =)$ negative pulse width	
Pulse Width Range	20ns ~10s	
Video Trigger		
Video Standard & Line Frequency	Support for standard NTSC, PAL and SECAM broadcast systems. Line number range: 1~525 (NTSC) and 1~625 (PAL/SECAM)	
Slope Trigger		

Trigger Condition	(>, <, =) positive slope, (>, <, =) negative slope
Time Setting	20ns~10s
Alternate Trigger	
Trigger on CH1	Edge, Pulse, Video, Slope
Trigger on CH2	Edge, Pulse, Video, Slope
Pattern Trigger^[2]	
Trigger Mode	D0~D15 select H, L, X, \neq , \neq
Duration Trigger^[2]	
Trigger Type	D0~D15 select H, L, X
Qualifier	>, <, =
Time Setup	20ns~10s

Measurements		
Cursor	Manual	Voltage difference between cursors (ΔV) Time difference between cursors (ΔT) Reciprocal of ΔT in Hertz ($1/\Delta T$)
	Track	Voltage value for Y-axis waveform Time value for X-axis waveform
	Auto	Cursors are visible for Automatic Measurement
Auto Measure	Vpp, Vamp, Vmax, Vmin, Vtop, Vbase, Vavg, Vrms, Overshoot, Preshoot, Freq, Period, Rise Time, Fall Time, +Width, -Width, +Duty, -Duty, Delay1→2 \neq , Delay1→2 \neq , Phas 1→2 \neq , Phas 1→2 \neq	

Remarks:

[1] When sampling is 1GSa/s, only single channel can be used.

[2] For DS1000D Series

General Specifications

Display	
Display Type	145 mm (5.6 inch) diagonal TFT Liquid Crystal Display
Display Resolution	320 horizontal ×RGB×234 vertical pixels
Display Color	64k color
Display Contrast (typical)	150:1
Backlight Brightness(typical)	300 nit

Probe Compensator Output	
Output Voltage(typical)	Approximately 3Vpp (peak to peak)
Frequency(typical)	1kHz

Power	
Supply Voltage	100 ~ 240 VAC _{RMS} , 45~440Hz, CAT II
Power Consumption	Less than 50W
Fuse	2A, T rating, 250 V

Environmental	
Ambient Temperature	Operating 10°C ~ 40°C
	Non-operating -20°C ~ +60°C
Cooling Method	Fan cooling
Humidity	below +35°C: ≤90% relative humidity
	+35°C ~ +40°C: ≤60% relative humidity
Altitude	Operating 3,000 m or below
	Non-operating 15,000 m or below

Mechanical		
Size	Width	303mm
	Height	154mm
	Depth	133 mm
Heavy	Without package	2.3 kg
	Packaged	3.5 kg

IP Protection

IP2X

Calibration Interval

The recommended calibration interval is one year

Chapter 6 Appendix

Appendix A: Accessories

Standard Accessories:

- Probe×2 (1.5m), (1:1 or 10:1 adjustable) Passive Probes

The passive probes have a 6MHz bandwidth with a rating of 150V CAT II when the switch is in the 1X position, and a Full oscilloscope bandwidth with a rating of 300 V CAT II when the switch is in the 10X position.

- A Power Cord that fits the standard of destination country
- A Data Cable (only for DS1000D series)
- A Active Logic Head (only for DS1000D series)
- 20 Logic Testing Nips (only for DS1000D series)
- 20 Logic Testing leads (only for DS1000D series)
- A CD-ROM (including User's Guide and Application Software)
- A Quick Guide

Optional Accessories:

- USB Cable
- BNC Cable
- RS232 Cable
- USB-GPIB Adapter
- DS1000E, DS1000D Soft Carrying Case

All accessories (standard and optional) are available by contacting your local **RIGOL** office.

Appendix B: Warranty

RIGOL warrants its products' mainframe and accessories in materials and workmanship within the warranty period. During the period concerned, **RIGOL** guarantees the free replacement or repair of products which are approved defective.

To get repair service or obtain a copy of the whole warranty statement, please contact with your nearest **RIGOL** sales and service office.

RIGOL do not provide any other warranty items except the one being provided by this warranty statement. The warranty items include but not being subjected to the hint guarantee items related to tradable characteristic and any particular purpose. **RIGOL** will not take any responsibility in cases regarding to indirect, particular and ensuing damage.

Appendix C: Care and Cleaning

General Maintenance

Do not store or leave the instrument in where the instrument will be exposed to direct sunlight for long periods of time.

Caution

To avoid damages to the instrument or probes, do not expose them to liquids which have causticity.

Cleaning

Clean the instrument and probes regularly based on its operating conditions requires.

To clean the exterior surface, perform the following steps:

1. Disconnect the instrument from all power sources.
2. Clean the loose dust on the outside of the instrument and probes with a lint-free cloth (with a mild detergent and water). When clean the LCD, take care to avoid scarifying it.



WARNING: To avoid injury resulting from short circuit, make sure the instrument is completely dry before reconnecting into a power source.

Appendix D: Contact Us

If you have any problem or requirement when using our products or this manual, please contact **RIGOL**.

E-mail: service@rigol.com

Website: www.rigol.com

Index

50%	1-18, 2-34	HF Reject	2-52
AC Coupling	2-3	Horizontal	5-2
AC Line	2-51	I/O setup	2-69
Accessories	6-1, 6-2	Inputs	5-2
Acquisition	5-2	Instant Execute Key	2-102
Alternative Trigger	2-42	Invert a waveform	2-9
Appendix	6-1, 6-4	Language	2-70
AUTO	2-102, 2-103	LEVEL	2-34
Auto Trigger	2-51	LF Reject	2-52
Automatic Measurement	2-88	Math	2-10
Average Acquisition	2-56	Measurements	5-5
Bandwidth Limit	2-5	Normal Trigger	2-51
Blackman Window	2-12	Nyquist Frequency	2-13
Channel Coupling	2-3	Optional	6-1
Cleaning	6-3	Pattern Trigger	2-46
Coarse/Fine	1-14, 2-9	Power	5-6
Cursor	2-95	Pretrigger	2-52
Cursor Measurements	2-95, 3-6	Probe Attenuation	2-6
DC Coupling	2-4	Probe compensation	1-9
Display	5-6	Probe Compensator	5-6
Display System	2-57	Pulse Trigger	2-37
Duration Trigger	2-47	Random Noise	3-4
Edge Trigger	2-36	Realtime Sampling	2-56
Envelope	2-56	Rectangle Window	2-12
Equivalent Sampling	2-56	REF	2-14
Ext and Ext/5	2-51	Roll Mode Display	2-29
Factory Setup	2-65	RUN/STOP	2-102
FFT	2-11	Sampling System	2-53
FORCE	1-18, 2-34	Save and Recal	2-59
Front panel	1-3	Self- Calibration	2-84
Functional check	1-7	Single Trigger	2-52
GND Coupling	2-4	Slope Trigger	2-39
Hamming Window	2-12	STORAGE	2-59
Hanning Window	2-12	Sync Pulses	2-41

Trigger.....	5-4	Vertical System.....	2-2
Trigger Control.....	1-17	Vertical Window.....	1-13
Trigger System	2-34	Video Trigger.....	2-40
UTILITY	2-67	X-Y	2-29
Vertical	5-3	Y-T	2-29